



SHARP®

MODEL

LC-40LE700X

LCD COLOUR TELEVISION

OPERATION MANUAL

AQUOS





OPERATION MANUAL

Dear SHARP customer

Thank you for your purchase of the SHARP LCD colour TV product. To ensure safety and many years of trouble-free operation of your product, please read the Important Safety Precautions carefully before using this product.

Contents

Introduction

Dear SHARP customer	1
Contents.....	1
Important Safety Precautions	4
Supplied accessories.....	5
Trademarks.....	5

Preparation

Attaching the stand.....	6
Part names.....	7
TV (Front/Side).....	7
TV (Rear)	8
Remote control unit	9
Before turning on the power	10
Supplying electric power to the antenna	11
Initial auto installation.....	11
Checking signal strength and channel strength	12
Connecting external devices	13
Connecting a VCR, game console or camcorder	13
Connecting a DVD player	13
Connecting a STB (Satellite, Cable, etc.).....	14
Connecting a PC.....	14
Inserting the batteries	15
Using the remote control unit.....	15
Cautions regarding the remote control unit.....	15
Turning the TV on/off.....	16
Turning on the power.....	16
Turning off the power.....	16
About Menu operations	17
What is Menu?	17
Basic Menu operations.....	17
About the Guide Display	17
Blue illumination Emblem	17
Menu items (TV/INPUT 4-6).....	18
Menu items (HDMI/RGB)	19

Watching TV

Setting channels automatically.....	20
Selecting programmes	21
Adjusting the volume	21
Menu language settings	21
Setting channels to your preference	22
Digital settings	22
Manual setting for each channel (Analogue).....	23
Sorting programmes	25
Erasing programmes.....	25
Useful viewing functions	26
Returning to the previously selected channel.....	26
Freezing the image	26
Muting the audio temporarily.....	26
Outputting only audio	26
Switching the analogue audio format	27
Switching the digital audio format	27
Password setting for the child lock (for TV input mode).....	28
Parental rate.....	29
Programme title display	29

Contents

Watching TV (Continued)

Key lock	29
Energy conservation settings	30
Auto power-off at a designated time	30
ECO picture control	30
Energy save	30
Auto power-off after the end of broadcast	30
Auto power-off when there are no operations performed	30
Quick start	31
Picture size settings	31
Selecting the Wide Screen Signalling (WSS) picture size automatically	31
Selecting the Wide Screen Signalling (WSS) picture size manually	31
Selecting the picture size manually	32
Selecting a preset AV MODE	33
Manual picture settings	34
Picture adjustment	34
Advanced picture settings	35
Other picture settings	36
Adjusting the image position	36
Game play time	36
Indicating time on the screen	37
Audio adjustment	38
Output volume select	38
Automatic volume adjustment	39
Clear voice	39
Digital audio output	39
Using Digital Audio Output	40
Programme Guide	40
Info	40
ATV (Analogue)/DTV/RADIO buttons	41
EPG	42
EPG display settings	42
Time zone	42
Selecting a programme using EPG	43
Basic Operation	43
Selecting a programme	43
Timer setting using EPG	45
Cancelling the timer setting	45

Settings when using external devices

Settings when using HDMI output devices	46
Selecting the input source and signal type	47
Selecting input source	47
Selecting input signal type	47
Selecting the size of the picture for recording	47
Labelling input sources	48
Skipping HDMI/RGB input	48
Colour system settings	48
Setting display colour	49
Channel selecting effect	49

AQUOS LINK

Controlling HDMI devices using AQUOS LINK	50
AQUOS LINK connection	51
Connecting an AQUOS BD Player/AQUOS Recorder via the AQUOS AUDIO speaker system	51
Connecting an AQUOS BD Player/AQUOS Recorder only	51
AQUOS LINK setup	51
AQUOS LINK control	51
Auto power on	52
Selecting recorder	52
Selecting channel key	52
Using genre info	52
Operating an AQUOS LINK device	52
Listening with the AQUOS AUDIO speaker system	53
Listening with the AQUOS TV speaker system	53
Manually changing the AQUOS AUDIO speaker system's sound mode	53
Calling up the menu of an external device connected with the TV via HDMI	53

Contents

AQUOS LINK (Continued)

Playback of titles using AQUOS LINK	53
Selecting media type for CEC-compatible recorder	54
HDMI device selection	54
Recording via the AQUOS Recorder EPG (only for recorders)	54

Connecting a PC

HDMI Connection	55
Analogue Connection	55
PC audio select	56
Displaying a PC image on the screen	56
Selecting the picture size	56
Adjusting the PC image automatically	57
Adjusting the PC image manually	57
PC Control of the TV	58
PC compatibility chart	59
RS-232C commands list	59

Teletext function

About Teletext	60
Teletext language setting	61
Displaying Subpages	61
Time display	61
Displaying Subtitles	62
Switching subtitle languages	62

Appendix

Troubleshooting	63
Troubleshooting-Digital broadcasting	63
Error messages about recording using AQUOS LINK	64
Reset	65
Download setup	65
Information	65
Message list	65
Receiver report	65
Identification	65
Specifications	66
Optional accessory	66
Dimensional drawings	67
Mounting the TV on the wall	68
Removing the stand	68
Handling and precautions with the wall-mounted TV	68
Protection against overturning	69
CLEARING THE PASSWORD	70
Information on the software license for this product	71

Important Safety Precautions

- **Cleaning** — Unplug the AC cord from the AC outlet before cleaning the product. Use a soft damp cloth to clean the product. Do not use liquid cleaners, aerosol cleaners or chemical cloth to clean it, as such materials may damage the product.



- **Water and moisture** — Do not use the product near water, such as bathtub, washbasin, kitchen sink, laundry tub, swimming pool and in a wet basement.



- Do not place vases or any other water-filled containers on this product. The water may spill onto the product causing fire or electric shock.



- **Stand** — Do not place the product on an unstable cart, stand, tripod or table. Doing so can cause the product to fall, resulting in serious personal injuries as well as damage to the product. Use only a cart, stand, tripod, bracket or table recommended by the manufacturer or sold with the product. When mounting the product on a wall, be sure to follow the manufacturer's instructions. Use only the mounting hardware recommended by the manufacturer.

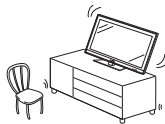

- When relocating the product placed on a cart, it must be moved with utmost care. Sudden stops, excessive force and uneven floor surface can cause the product to fall from the cart.



- **Ventilation** — The vents and other openings in the cabinet are designed for ventilation. Do not cover or block these vents and openings since insufficient ventilation can cause overheating and/or shorten the life of the product. Do not place the product on a bed, sofa, rug or other similar surface, since they can block ventilation openings. This product is not designed for built-in installation; do not place the product in an enclosed place such as a bookcase or rack, unless proper ventilation is provided or the manufacturer's instructions are followed.



- The LCD panel used in this product is made of glass. Therefore, it can break when the product is struck forcefully or with a sharp object. If the LCD panel is broken, be careful not to be injured by broken glass.



- **Heat sources** — Keep the product away from heat sources such as radiators, heaters, stoves and other heat-generating products (including amplifiers).



- To prevent fire, never place any type of candle or naked flames on the top or near the TV set.

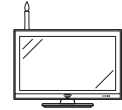

- To prevent fire or shock hazard, do not place the AC power cord under the TV set or other heavy items.



- Do not place heavy objects on this product or stand on it. Doing so could cause injury if the product overturns. Take special care near children and pets.

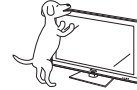

The LCD panel is a very high technology product with 2,073,600 pixels, giving you fine picture details. Due to the very large number of pixels, occasionally a few non-active pixels may appear on the screen as a fixed point of blue, green or red. This is within product specifications and does not constitute a fault.

Precautions when transporting the TV

Be sure to always carry the TV by two people holding it with two hands — one hand on each side of the TV.

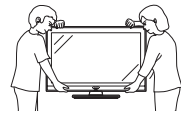

- Do not display a still picture for a long time, as this could cause an afterimage to remain.





- Install the product on the place where the AC cord can be unplugged easily from the AC outlet, or from the AC INPUT terminal on the rear of the product.

If a television is not positioned in a sufficiently stable location, it can be potentially hazardous due to falling. Many injuries, particularly to children, can be avoided by taking simple precautions such as:

- Using cabinets or stands recommended by the manufacturer of the television.
- Only using furniture that can safely support the television.
- Ensuring the television is not overhanging the edge of the supporting furniture.
- Not placing the television on tall furniture (for example, cupboards or bookcases) without anchoring both the furniture and the television to a suitable support.
- Not standing the televisions on cloth or other materials placed between the television and supporting furniture.
- Educating children about the dangers of climbing on furniture to reach the television or its controls.

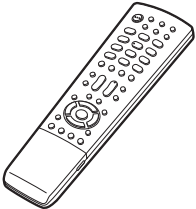
Supplied accessories

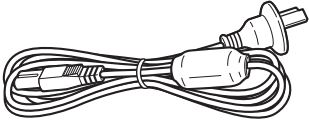
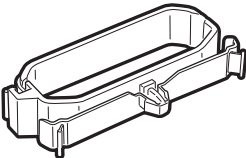
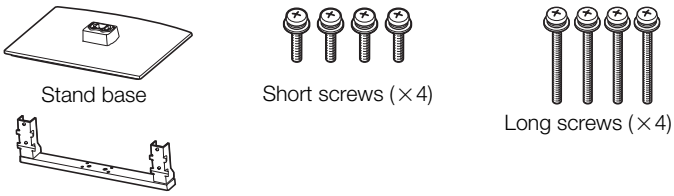
Make sure the following accessories are provided with the product.

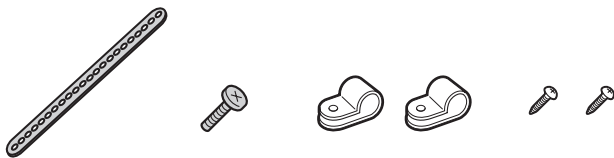
<p>Remote control unit</p>  <p>Used with batteries inserted. Page 9</p>	<p>"AAA" size battery (×2)</p>  <p>Page 15</p>	<p>AC cord</p>  <p>Always use the AC cord supplied with the TV. Page 10</p>
<p>Cable clamp</p>  <p>For bundling cables. Page 10</p>	<p>Stand unit</p>  <p>Stand base Short screws (×4) Long screws (×4) Stand post</p> <p>Put all parts of the stand unit together and then attach it to the TV. Page 6</p>	
<p>Operation manual</p> 	<p>Safety restrains</p>  <p>Restraining band Screw for band Clamps Screws for clamps</p> <p>Page 69</p>	

Trademarks

- TruSurround HD, SRS and  symbol are trademarks of SRS Labs, Inc. TruSurround HD technology is incorporated under license from SRS Labs, Inc.
- Manufactured under license from Dolby Laboratories. Dolby and the double-D symbol are trademarks of Dolby Laboratories.
- "HDMI, the HDMI logo and High-Definition Multimedia Interface are trademarks or registered trademarks of HDMI Licensing LLC."
- LCフォント、LCFONT、エルシーフォント and LC logo mark are registered trademarks of SHARP Corporation. This product is embedded with LC Font technology, which was developed by SHARP Corporation for clearly displaying easy-to-read characters on LCD screens. However, other fonts are used for some screen pages, too.

Preparation

Attaching the stand

- Before attaching (or detaching) the stand, unplug the AC cord from the AC INPUT terminal.
- Before performing work, spread cushioning over the base area to lay the TV on. This will prevent it from being damaged.

CAUTION

- **Attach the stand in the correct direction.**
- **Be sure to follow the instructions. Incorrect installation of the stand may result in the TV falling over.**

1 Confirm the 8 screws supplied with the TV.

Short screws (×4)
(used in step 3)



Long screws (×4)
(used in step 2)

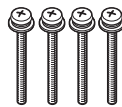

2 Attach the supporting post for the stand unit onto the base as shown below.

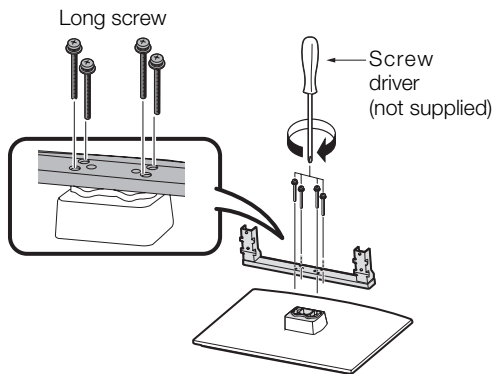

3 ① Insert the stand into the openings on the bottom of the TV.
② Insert and tighten the 4 short screws into the 4 holes on the rear of the TV.

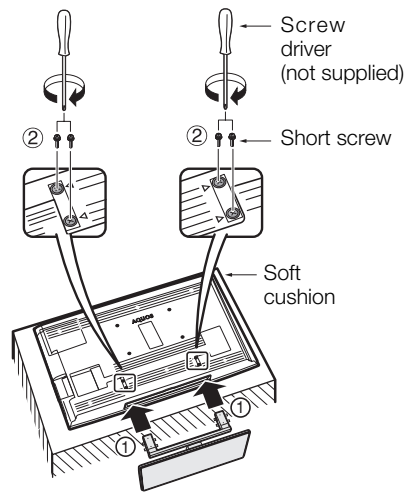

NOTE

- To detach the stand, perform the steps in reverse order.

Preparation

Part names

TV (Front/Side)

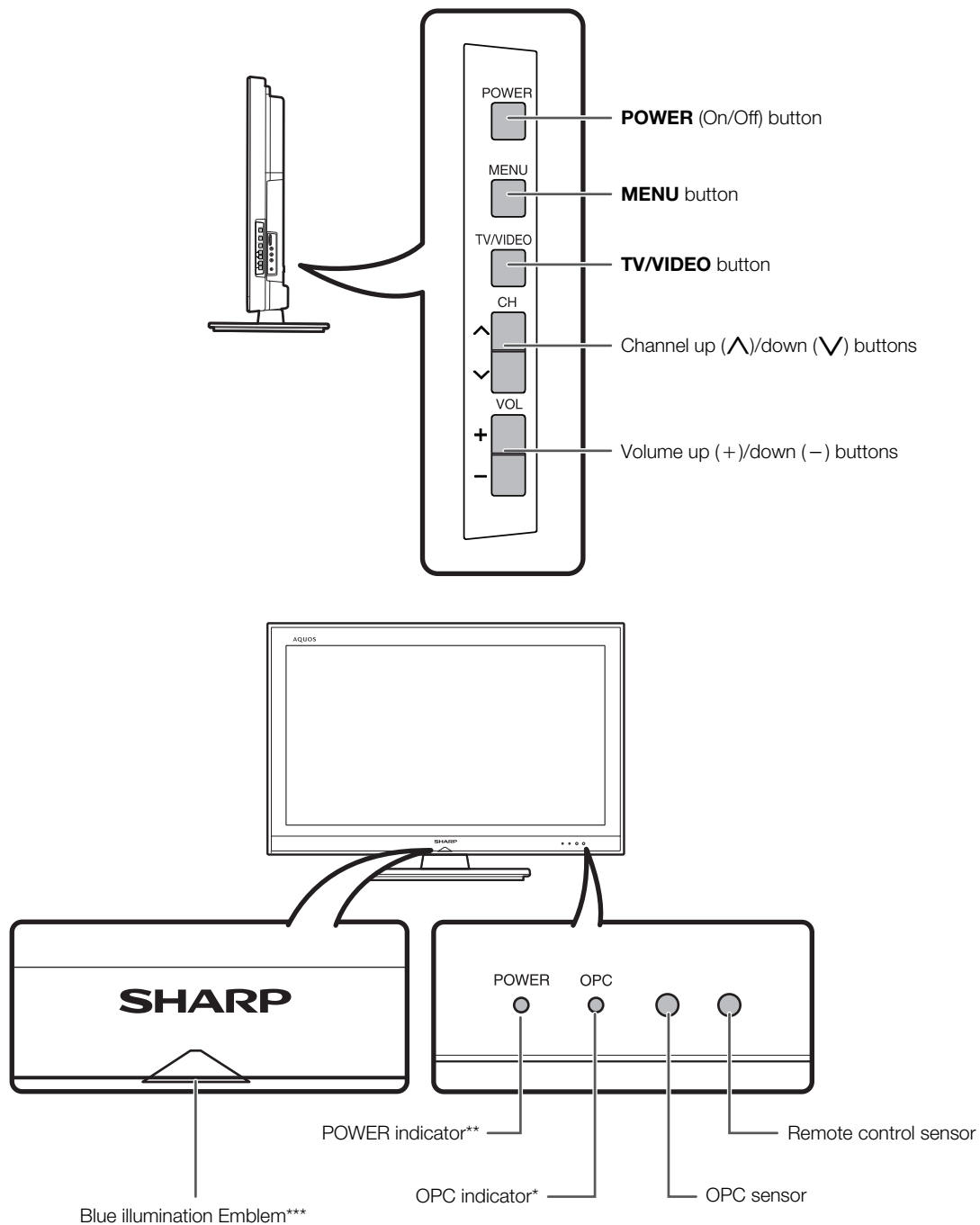

*OPC: Optical Picture Control (See page 34.)

** See page 16 for the TV status indicator.

*** Blue illumination Emblem (See page 17.)

• The illustrations in this operation manual are for explanation purposes and may vary slightly from the actual operations.

Preparation

TV (Rear)

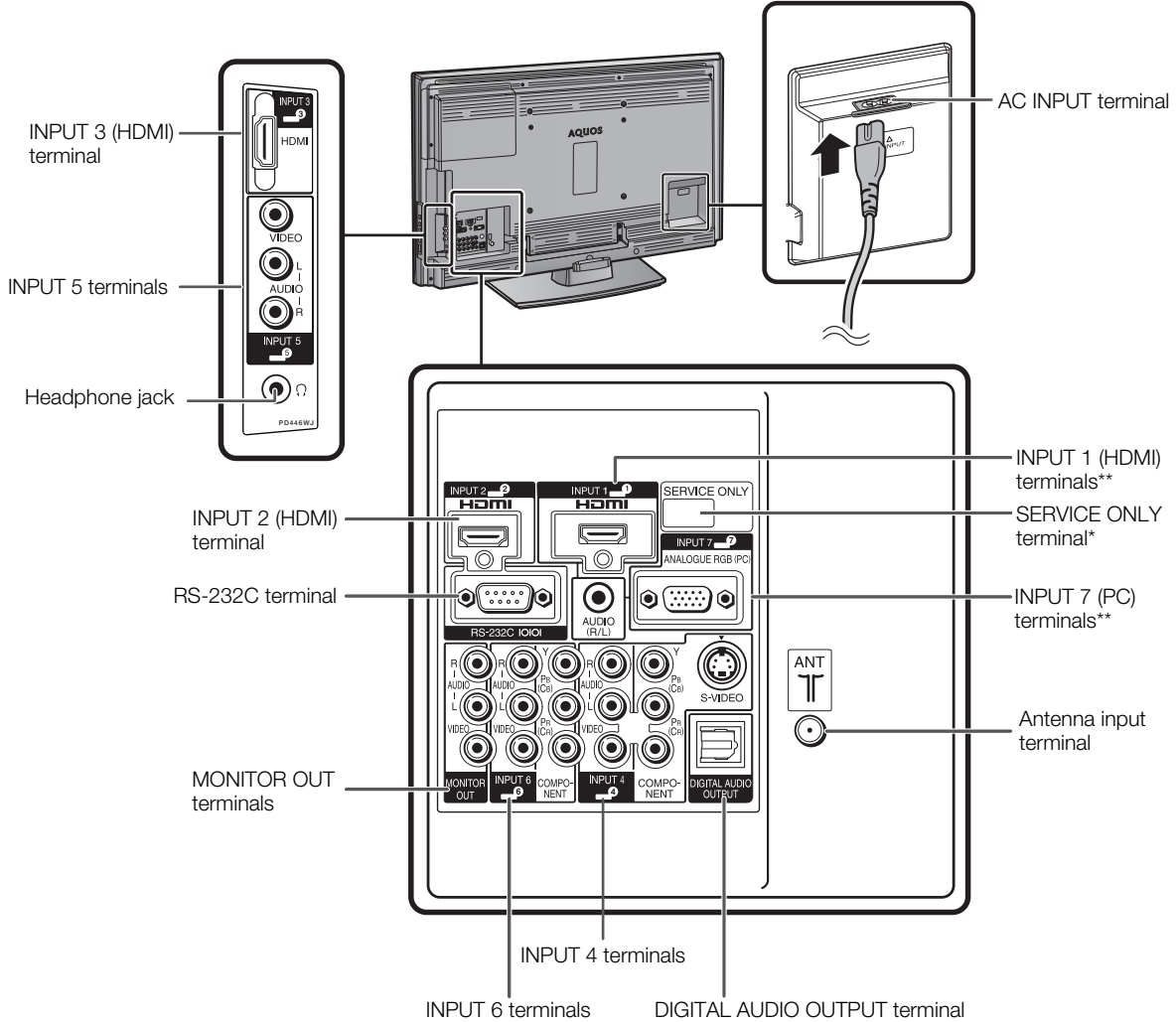

*Usually do not connect anything to this terminal as it is reserved only for service personnel.

**The INPUT 1 and INPUT 7 terminals can both use the same audio input terminal. However, the proper item must be selected in the "PC audio select" menu. (See page 56.)

Regarding the headphone jack

- Use headphones with a stereo mini plug (ϕ 3.5 mm).
- Be sure to unplug headphones from the jack when they are not in use.
- The speakers do not output volume when headphones are plugged in.
- The "Audio" menu cannot be operated when headphones are plugged in.
- You can set the volume to different levels for each input source.

Volume display when headphones are plugged in



Preparation

Remote control unit

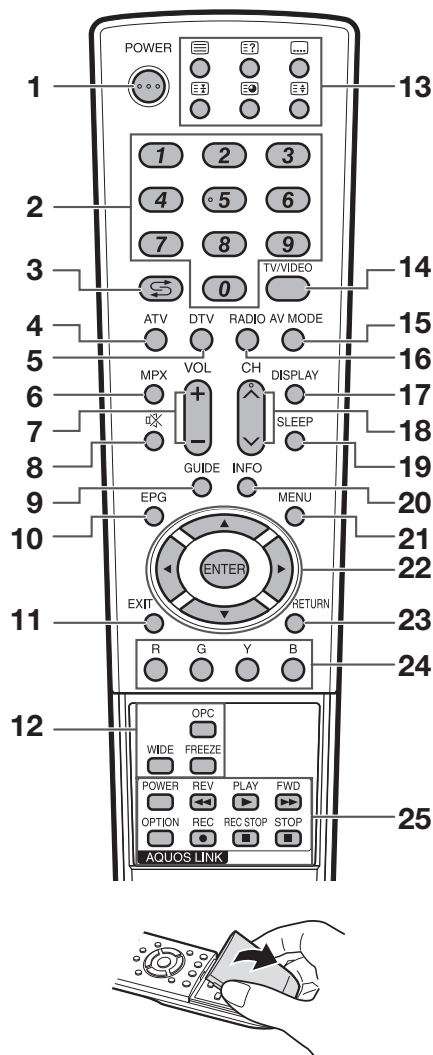

- 1 POWER (STANDBY/ON)**
To switch the power on and off. (See page 16.)
- 2 0 - 9**
Set the channel. (See page 21.)
TELETEXT mode: Set the page. (See pages 60 and 61.)
- 3 (Flashback)**
Press to return to the previous selected channel or external input mode. (See page 26.)
- 4 ATV**
Press to access ANALOGUE mode. (See page 41.)
- 5 DTV**
Press to access DTV mode. (See page 41.)
- 6 MPX**
Select the sound multiplex mode. (See page 27.)
- 7 VOL + /VOL -**
Set the volume. (See page 21.)
- 8 (Mute)**
Mute the sound. (See page 26.)
- 9 GUIDE**
DTV mode: Display the programme list. (See page 40.)

- 10 EPG**
DTV mode: To display EPG (Electronic Programme Guide) screen. (See pages 42 to 45.)
- 11 EXIT**
Turn off the On-Screen Display.
- 12 OPC**
To switch the Optical Picture Control on and off. (See page 34.)
- WIDE**
Change the wide image mode. (See pages 32 and 56.)
- FREEZE**
Freeze a motion picture on the screen. (See page 26.)
- 13 (TELETEXT)**
Select the TELETEXT mode. (all TV image, all TEXT image, TV/TEXT image) (See pages 60 to 61.)
- (Reveal hidden for TELETEXT)**
TELETEXT mode: Display hidden characters. (See page 60.)
- (SUBTITLE)**
To turn the subtitles on and off. (See page 62.)
- (Hold)**
TELETEXT mode: Stop updating Teletext pages automatically. Press again to release the hold mode. (See page 60.)
- (Subpage)**
Display the Teletext subpage directly. (See page 61.)
- (Top/Bottom/Full)**
TELETEXT mode: Set the area of magnification. (See page 60.)
- 14 TV/VIDEO (INPUT SOURCE)**
Select an input source. (TV, INPUT1, INPUT2, INPUT3, INPUT4, INPUT5, INPUT6, INPUT7 (PC)) (See pages 13, 46, 48 and 55.)
- 15 AV MODE**
Select a video setting. (See page 33.)
- 16 RADIO**
Press to access RADIO mode. (See page 41.)
- 17 DISPLAY**
Displays the channel or input information.
DTV mode: Displays the time information included in the DTV broadcast.
ATV mode: Displays the time information included in the Teletext broadcast. (See page 61.)
- 18 CH ^ / CH v**
TV input mode: Select the channel. (See page 21.)
TELETEXT mode: Select the page. (See pages 60 and 61.)
- 19 SLEEP**
Set the Sleep timer. (See page 30.)
- 20 INFO**
DTV mode: Display the programme information. (See page 40.)
- 21 MENU**
Display the menu screen. (See page 17.)
- 22 (Cursor)**
Select a desired item on the setting screen.
- ENTER**
Execute a command.
- 23 RETURN**
MENU mode: Return to the previous menu screen. (See page 17.)
- 24 Colour (Red/Green/Yellow/Blue)**
TELETEXT mode: Select a page. (See page 60.)
- 25 AQUOS LINK buttons**
If external equipment such as a AQUOS BD Player is connected via HDMI cables and is AQUOS LINK compatible, you can use these AQUOS LINK buttons. (See pages 50 to 54 for details.)

Preparation

Before turning on the power

Notes on installing the TV

- Avoid direct sunlight and place the TV in a well-ventilated location.
- Place the TV in a level location.
- Do not turn on the power of the TV before connecting the AC cord.

1 Connecting the antenna cable

To enjoy a clearer picture, use an outdoor antenna. The following is a brief explanation of the types of connections that are used for coaxial cable.

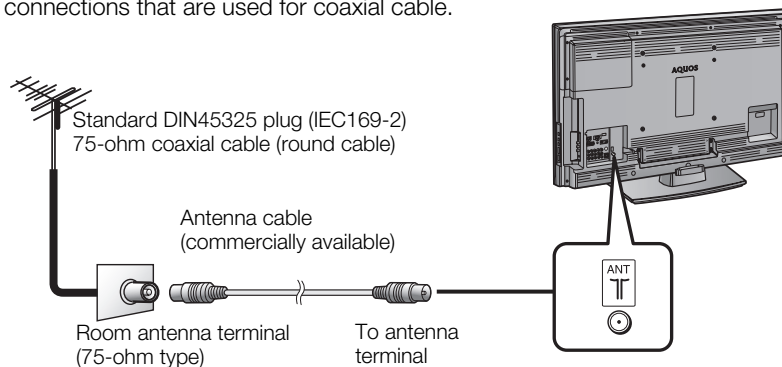

2 Connecting external devices

See pages 13 and 14 for connecting external equipment, such as a VCR and DVD player.

3 Connecting the AC cord

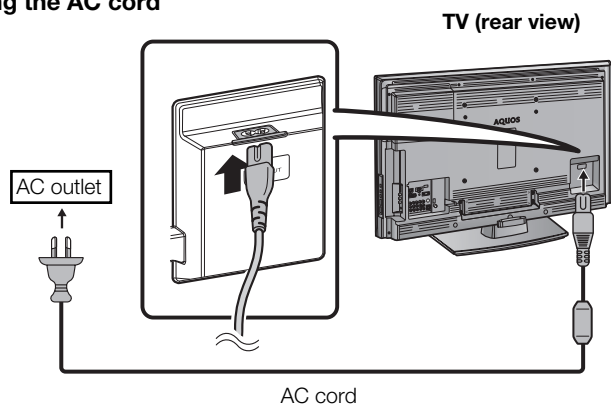

- Place the TV close to the AC outlet, and keep the power plug within reach.
- Disconnect the AC cord from the AC outlet if the TV will not be used for a long period of time.

4 Bundling the cables

Insert the cable clamp in the hole on the TV as shown.

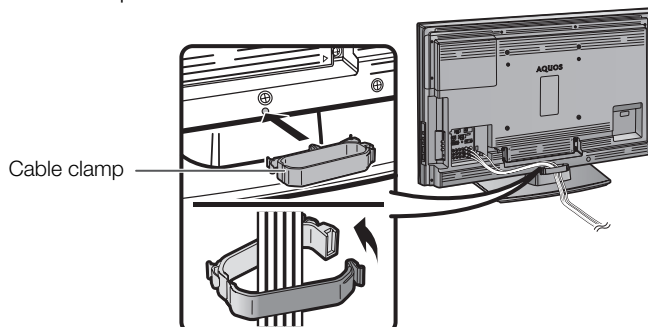

CAUTION

- TO PREVENT RISK OF ELECTRIC SHOCK, DO NOT TOUCH UN-INSULATED PARTS OF ANY CABLES WITH THE AC CORD CONNECTED.

Preparation

Supplying electric power to the antenna

When you set-up the DTV antenna for the first time, or connect the antenna to a community antenna, you need to proceed to set the antenna by following this manual.

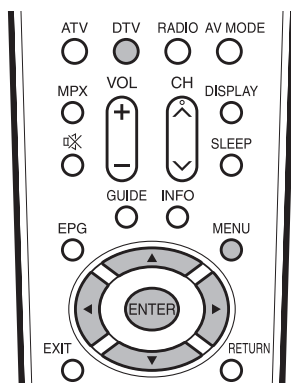

- 1 Press **DTV** to access DTV mode.
- 2 Press **MENU** and the MENU screen displays.
- 3 Press **◀▶** to select "Setup".
- 4 Press **▲▼** to select "Antenna setup-DIGITAL" and then press **ENTER**.
- 5 Press **▲▼** to select "Supply voltage" and then press **ENTER**.
- 6 Press **◀▶** to select "On" and then press **ENTER**.

Selected item	Description
On	Select "On" when your antenna is set-up and connected independently. Typical supply voltage: 5V Typical supply current: 50mA
Off	Select "Off" when you do not need to supply voltage to your antenna, i.e. when your antenna is connected to a community antenna. (The factory default setting of this function is "Off".)

Initial auto installation

When the TV powers on for the first time after purchase, the initial auto installation wizard appears. Follow the menus and make the necessary settings one after another.

Confirm the following before turning on the power

- Is the antenna cable connected?
- Is the AC cord plugged in?

- 1 Press **POWER** on the TV.
 - The initial auto installation wizard appears.

- 2 Setting the on-screen display language.



- 3 Press **▲▼** to select the desired language, and then press **ENTER**. Press **◀▶** to select "HOME" or "STORE", and then press **ENTER**.

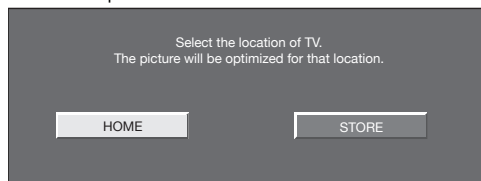

- HOME: "STANDARD" will be the default value for the "AV MODE" setting.
- STORE: "DYNAMIC (Fixed)" will be the default value for the "AV MODE" setting. If the "AV MODE" is changed, the TV will automatically switch back to "DYNAMIC (Fixed)" when there is no further change to TV setting for 30 minutes.

- 4 Press **ENTER**.

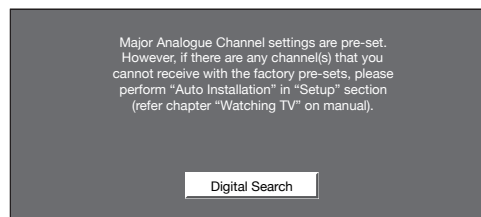

- Major Analogue Channel settings are pre-set. However, if there are any channel(s) that you cannot receive with the factory pre-sets, please perform "Auto installation" in "Setup" section. (See page 20.)

Preparation

Initial auto installation (continued)

5 The TV searches for, sorts and stores all the receivable TV stations according to their settings and the connected antenna.

- To abort the initial auto installation in progress, press **RETURN**.

NOTE

- HOME mode: Settings are optimised for normal home viewing and energy efficiency.
- STORE mode: Settings are designed for maximum impact in retail store displays.
- To change the STORE mode to HOME mode, please refer to page 65 to reset the unit.
- If you turn off the power on the TV after performing step 4, the initial auto installation wizard does not appear. The auto installation function allows you to execute the auto installation again from the Setup menu. (Page 20)
- The initial auto installation wizard will go off if you leave the TV unattended for 30 minutes before searching for channels in step 5.

Checking signal strength and channel strength

If you install a DVB-T antenna for the first time or relocate it, you should adjust the alignment of the antenna to receive a good reception while checking the antenna setup screen.

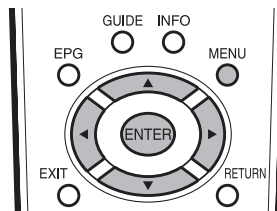

1 Press **MENU** and the MENU screen displays.

2 Press **◀▶** to select "Setup".

3 Press **▲/▼** to select "Antenna setup-DIGITAL", and then press **ENTER**.

Checking signal strength

Press **▲/▼** to select "Signal strength".

Supply voltage	
Signal strength	
Channel strength	CH No. 21
	Signal strength
	Current 0 Max. 0
	Quality
	Current 0 Max. 0

Checking channel strength

Press **▲/▼** to select "Channel strength", and then press **ENTER**.

Supply voltage	2 6 5 . 2 MHz
Signal strength	
Channel strength	CH No. 21
	Signal strength
	Current 0 Max. 0
	Quality
	Current 0 Max. 0

4 Position and align the antenna so that the maximum possible values for "Signal strength" and "Quality" are obtained.

NOTE

- The values of "Signal strength" and "Quality" indicate when to check the appropriate alignment of the antenna.

Preparation

Connecting external devices

You can connect many types of external equipment to your TV, like a VCR, game console, camcorder, DVD player, Digital TV STB (Set Top Box) and PC. To view input source images, select the input source from **TV/VIDEO** on the remote control unit or **TV/VIDEO** on the TV.

CAUTION

- To protect all equipment, always turn off the TV before connecting to a VCR, game console, camcorder, DVD player, Digital TV STB (Set Top Box), PC or other external equipment.
- Refer to the relevant operation manual (VCR, DVD player, etc.) carefully before making connections.

Connecting a VCR, game console or camcorder

A VCR, game console, camcorder and some other audiovisual equipment can be conveniently connected using the INPUT 5 or INPUT 4/INPUT 6 terminals.

When using component cable (commercially available)

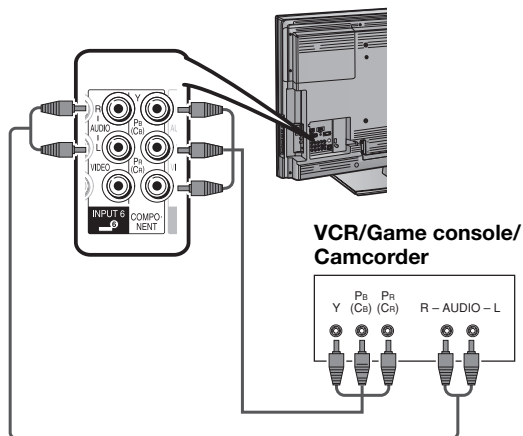

When using composite cable or S-VIDEO cable (commercially available)

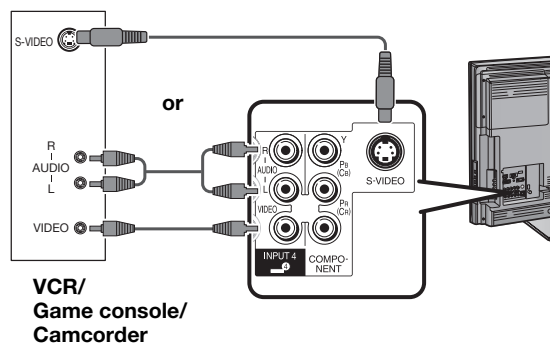

Connecting a DVD player

You can use the INPUT 1/INPUT 2/INPUT 3 (HDMI) or INPUT 4/INPUT 6 terminals when connecting to a DVD player and other audiovisual equipment.

When using HDMI cable (commercially available)

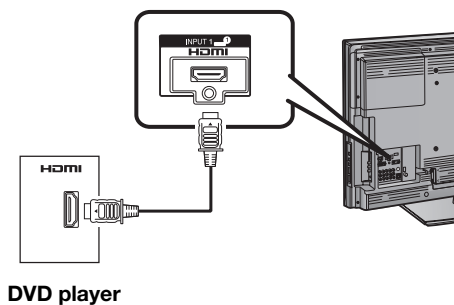

When using component cable (commercially available)

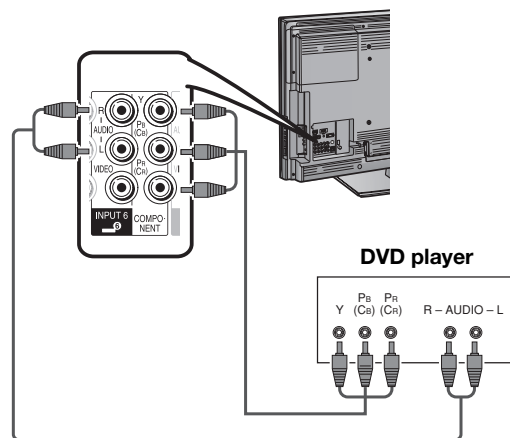

Preparation

Connecting a STB (Satellite, Cable, etc.)

You can use the INPUT 1/INPUT 2/ INPUT 3 (HDMI) or INPUT 4/INPUT 6 terminals when connecting to a STB (Satellite, Cable, etc.) and other audiovisual equipment.

When using HDMI cable (commercially available)

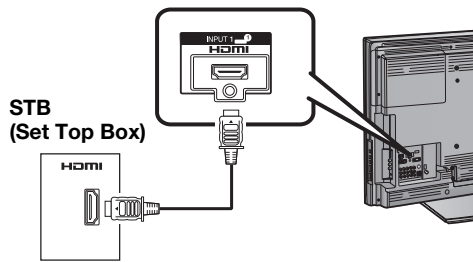

When using component cable (commercially available)

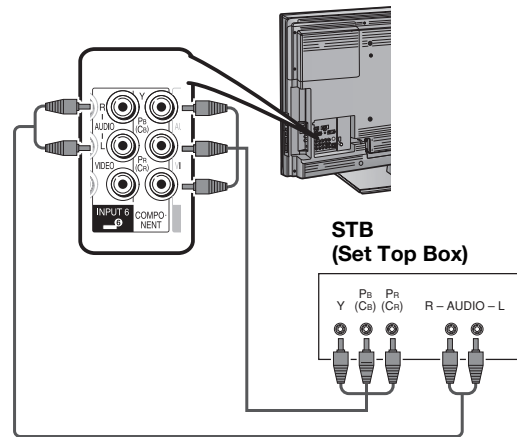

Connecting a PC

You can use the INPUT 7 (PC) terminal when connecting to a PC.

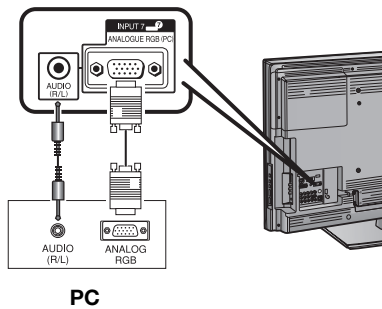

Preparation

Inserting the batteries

Before using the TV for the first time, insert two "AAA" size batteries (supplied). When the batteries become depleted and the remote control fails to operate, replace the batteries with new "AAA" size batteries.

- 1 Open the battery cover.
- 2 Insert the two supplied "AAA" size batteries.
- 3 Close the battery cover.

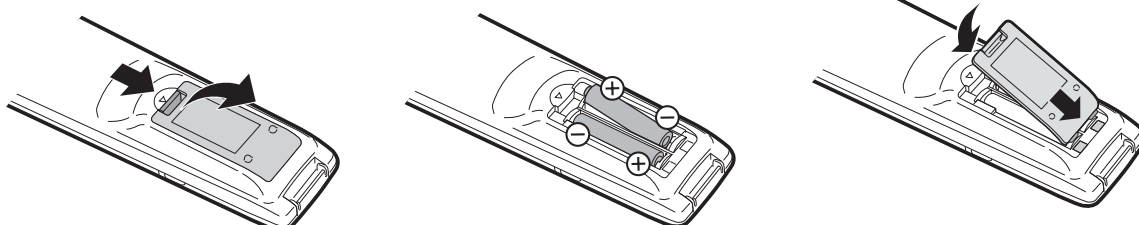

- Place batteries with their terminals corresponding to the (+) and (-) indications in the battery compartment.

CAUTION

Improper use of batteries can result in chemical leakage or explosion. Be sure to follow the instructions below.

- Do not mix batteries of different types. Different types of batteries have different characteristics.
- Do not mix old and new batteries. Mixing old and new batteries can shorten the life of new batteries or cause chemical leakage in old batteries.
- Remove batteries as soon as they have worn out. Chemicals that leak from batteries can cause a rash. If you find any chemical leakage, wipe thoroughly with a cloth.
- The batteries supplied with this product may have a shorter life expectancy due to storage conditions.
- If you will not be using the remote control unit for an extended period of time, remove the batteries from it.
- Batteries (battery pack or batteries installed) shall not be exposed to excessive heat such as sunshine, fire or the like.

Using the remote control unit

Use the remote control unit by pointing it towards the remote sensor window.

Objects between the remote control unit and sensor window may prevent proper operation.

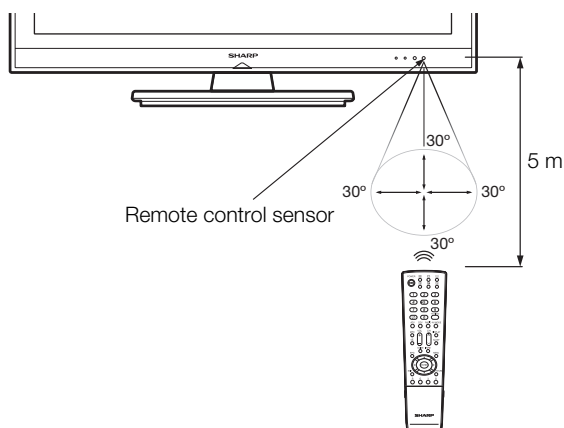

Cautions regarding the remote control unit

- Do not subject the remote control unit to shock. In addition, do not soak the remote control unit with liquids or place it in an area with high humidity.
- Do not install or place the remote control unit under direct sunlight. The heat may cause deformation of the unit.
- The remote control unit may not work properly if the remote sensor window of the TV is under direct sunlight or strong lighting. In such cases, change the angle of the lighting or TV, or operate the remote control unit closer to the remote sensor window.

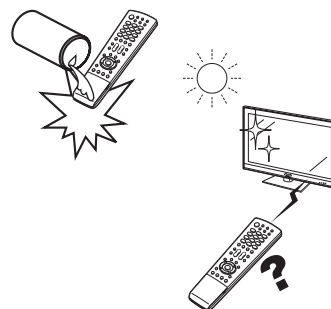

Preparation

Turning the TV on/off

Turning on the power

Press **POWER** on the TV.

- POWER indicator (Green): The TV is on. (After a few seconds, an image appears with sound.)
- After turning the power "ON" by pressing **POWER** on the TV, you can turn the power ON/OFF by pressing **POWER** on the remote control.

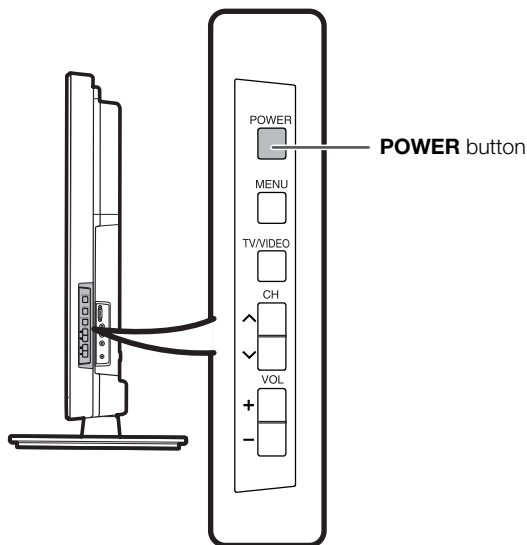

Turning off the power

POWER button

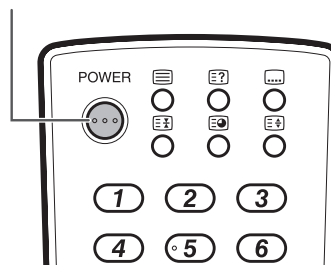

Press **POWER** on the remote control.

- The TV enters standby mode and the image on the screen disappears.
- The POWER indicator on the TV changes from green to red.

Press **POWER** on the TV.

- The POWER indicator on the TV turns off.
- When the TV is turned off by **POWER** on the TV, you cannot turn on the power by pressing **POWER** on the remote control.

POWER indicator

Light off	Power off
Lighted (Red)	The TV is in standby mode.
Lighted (Green)	The TV is on.

NOTE

- If you are not going to use this TV for a long period of time, be sure to remove the AC cord from the AC outlet.
- Minor power is consumed when the unit is in standby mode.

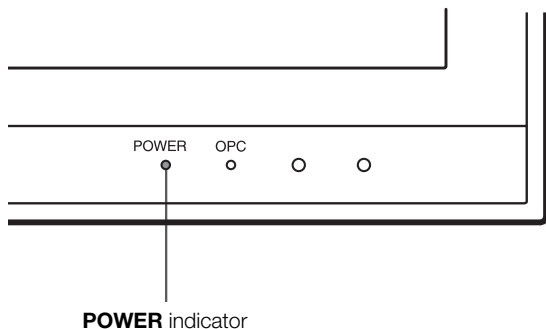

Preparation

About Menu operations

What is Menu?

- You need to bring up the On-Screen Display to perform settings for the TV. The On-Screen Display for the settings is called "Menu".
- The Menu enables various settings and adjustments. (See pages 18 and 19.)
- The Menu can be operated with the remote control unit.

Basic Menu operations

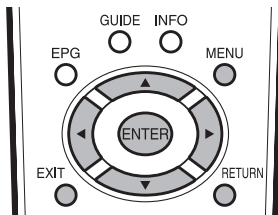

- 1 Press **MENU** and the MENU screen displays.

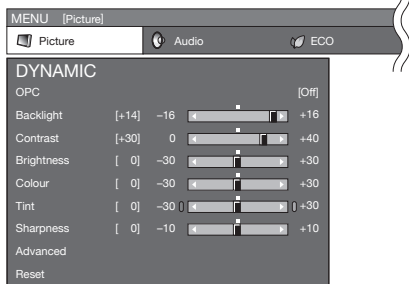

- 2 Press **◀/▶** to select the desired menu, and then press **ENTER**.

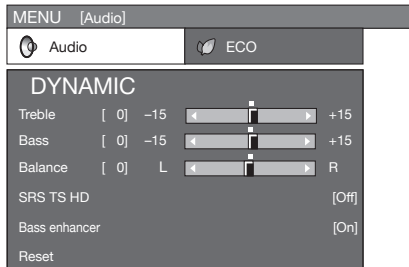

- 3 Press **▲/▼** to select the desired menu item. Press **ENTER** to proceed if necessary.

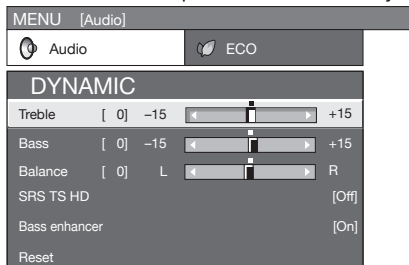

- 4 Press **▲/▼** or **◀/▶** to select the desired item or adjust the item to the desired level. Press **ENTER** if necessary.

- 5 Press **EXIT** or **MENU** to exit the MENU. Press **RETURN** as necessary to return to the previous MENUS.

Using the control panel of the TV

You can also operate the Menu using the control panel of the TV.

Button operations on the control panel correspond to the ones on the remote control as shown below.

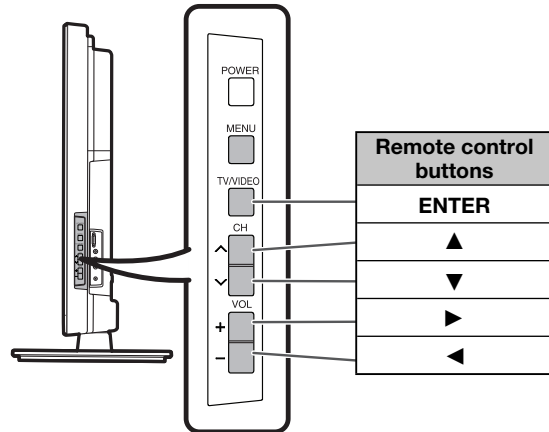

NOTE

- Menu options differ in the selected input modes, but the operating procedures are the same.
- The screens in the operation manual are for explanation purposes (some are enlarged, others cropped) and may vary slightly from the actual screens.

About the Guide Display

The Guide Display at the bottom of the screen shows operations with an On-Screen Display.

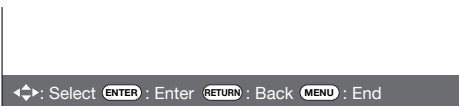

The bar above is an operational guide for the remote control. The bar will change in accordance with each menu setting screen.

Blue illumination Emblem

You can choose to light up the Blue illumination Emblem.

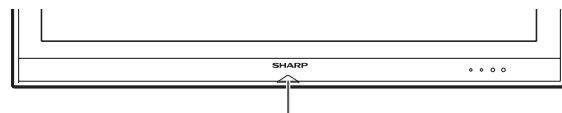

Blue illumination Emblem

- 1 Press **MENU** and the MENU screen displays.
- 2 Press **◀/▶** to select "Setup".
- 3 Press **▲/▼** to select "Blue illumination", and then press **ENTER**.
- 4 Press **▲/▼** to select "On" or "Off", and then press **ENTER**.

Preparation

Menu items (TV/INPUT 4-6)

List of menu items to help you with operations

Picture

OPC.....	Page 34
Backlight	Page 34
Contrast.....	Page 34
Brightness	Page 34
Colour.....	Page 34
Tint.....	Page 34
Sharpness	Page 34
Advanced	
C.M.S.-hue	Page 35
C.M.S.-saturation	Page 35
C.M.S.-value	Page 35
Colour temp.	Page 35
Fine motion advanced	Page 35
Film mode.....	Page 35
Active contrast.....	Page 35
Gamma adjustment.....	Page 35
DNR.....	Page 35
3D-Y/C	Page 35
Monochrome	Page 35
Range of OPC.....	Page 36
Reset.....	Page 34

Option

AQUOS LINK setup	Page 51
Input select	Page 47
PC audio select.....	Page 56
Output volume select	Page 38
Auto volume	Page 39
Clear voice	Page 39
Digital audio output	Page 39
Audio only.....	Page 26
Programme title display.....	Page 29
Time display	Page 37
Game play time.....	Page 36
Colour system.....	Page 48
Key lock.....	Page 29
Setting display colour	Page 49
Channel selecting effect	Page 49

Digital setup

REC picture size	Page 47
Download setup.....	Page 65
EPG setup	Page 42
Subtitle	Page 62
Time zone.....	Page 42

Audio

Treble.....	Page 38
Bass.....	Page 38
Balance.....	Page 38
SRS TS HD	Page 38
Bass enhancer	Page 38
Reset.....	Page 38

Information

Message list.....	Page 65
Receiver report.....	Page 65

ECO

Eco picture control	Page 30
Energy save.....	Page 30
No signal off.....	Page 30
No operation off.....	Page 30

Setup

Auto installation.....	Page 20
Programme setup.....	Pages 22-25
Child lock	Page 28
Antenna setup-DIGITAL.....	Page 12
Input skip.....	Page 48
Input label.....	Page 48
Position.....	Page 36
WSS	Page 31
4:3 mode.....	Page 31
Quick start	Page 31
Language.....	Page 21
Text language	Page 61
Blue illumination	Page 17
Identification	Page 65
Reset.....	Page 65

NOTE

- Some menu items may not be displayed depending on the selected input source.

Preparation

Menu items (HDMI/RGB)

List of menu items to help you with operations

Picture

OPC.....	Page 34
Backlight	Page 34
Contrast.....	Page 34
Brightness.....	Page 34
Colour.....	Page 34
Tint.....	Page 34
Sharpness	Page 34
Advanced	
C.M.S.-hue	Page 35
C.M.S.-saturation	Page 35
C.M.S.-value	Page 35
Colour temp.	Page 35
Fine motion advanced.....	Page 35
Gamma adjustment	Page 35
Film mode.....	Page 35
Active contrast.....	Page 35
DNR	Page 35
Monochrome.....	Page 35
Range of OPC.....	Page 36
Reset.....	Page 34

Audio

Treble.....	Page 38
Bass.....	Page 38
Balance.....	Page 38
SRS TS HD	Page 38
Bass enhancer	Page 38
Reset.....	Page 38

ECO

ECO picture control.....	Page 30
Energy save.....	Page 30
No signal off.....	Page 30
No operation off.....	Page 30

Setup

Input skip.....	Page 48
Auto sync.	Page 57
Input label.....	Page 48
Position.....	Page 36
Fine sync.	Page 57
HDMI auto view	Page 46
Quick start.....	Page 31
Language.....	Page 21
Blue illumination	Page 17
Reset.....	Page 65

Option

AQUOS LINK setup	Page 51
PC audio select.....	Page 56
Output volume select.....	Page 38
Auto volume	Page 39
Clear voice	Page 39
Audio only.....	Page 26
Time display	Page 37
Game play time.....	Page 36
Key lock.....	Page 29
Setting display colour	Page 49
Channel selecting effect	Page 49

Information

Message list.....	Page 65
Receiver report.....	Page 65

NOTE

- Some menu items may not be displayed depending on the selected input source.

Watching TV

Setting channels automatically

You can run auto installation again, even after setting up the preset channels.

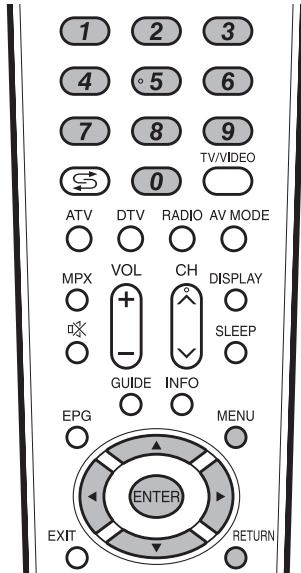

1 Press **MENU** and the MENU screen displays.

2 Press **◀▶** to select "Setup".

3 Press **▲▼** to select "Auto installation", and then press **ENTER**.

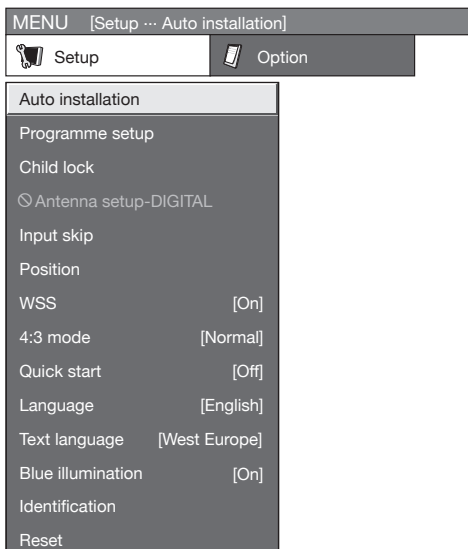

4 If you have already set the password, enter it here.

- See page 28 for setting a password.

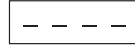

5 Press **◀▶** to select "Yes", and then press **ENTER**.

6 Press **▲▼** to select the desired language listed on the screen, and then press **ENTER**. Press **◀▶** to select "Digital Search" or "Analogue Search", and then press **ENTER**. You do not need to do anything during the auto search. Press **RETURN** to exit.

Watching TV

Selecting programmes

You can change channels in several ways.

Using CH \wedge / \vee on the remote control unit

- Press **CH \wedge** to increase the channel number.
- Press **CH \vee** to decrease the channel number.

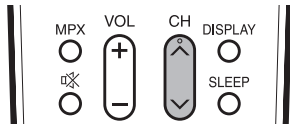

NOTE

- **CH \wedge / \vee** on the TV operates the same as **CH \wedge / \vee** on the remote control unit.

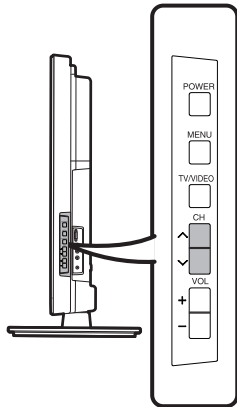

Using 0–9 on the remote control unit

Select the channels directly by pressing buttons **0** to **9**.

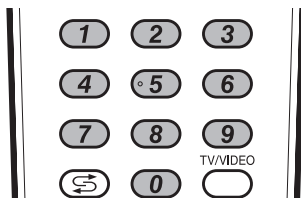

EXAMPLE

To select a 1-digit channel (e.g. channel 2):

- Press **0**, followed by **2**.

To select a 2-digit channel (e.g. channel 12):

- Press **1**, followed by **2**.

To select a 3-digit channel (e.g. channel 020):

- Press **0**, press **2**, followed by **0**.

When viewing Teletext information

View a page directly which is 3-digit page number from 100 to 899 by pressing buttons **0** to **9**.

Adjusting the volume

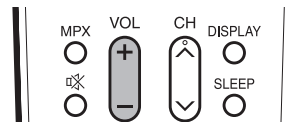
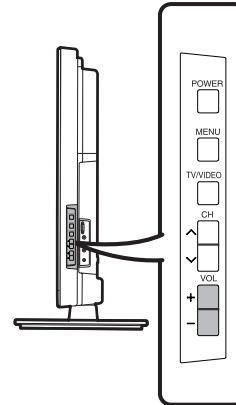

Changing the volume

You can change the volume on the TV or on the remote control unit.

- To increase the volume, press **VOL +**.
- To decrease the volume, press **VOL -**.



NOTE

- "TV", "INPUT1", "INPUT2", "INPUT3", "INPUT4", "INPUT5", "INPUT6" and "INPUT7" (PC) modes can store volume adjustment values separately.

Menu language settings

You can also select a language from setup menu. Select from among 3 languages: English, Simplified Chinese and Arabic.

1 Press **MENU** and the MENU screen displays.

2 Press **◀▶** to select "Setup".

3 Press **▲/▼** to select "Language", and then press **ENTER**.

4 Press **▲/▼** to select the desired language listed on the screen, and then press **ENTER**.

Watching TV

Setting channels to your preference

You can run the auto search procedure again at any time by accessing the Setup menu and Programme setup. Channels can be tuned automatically or manually.

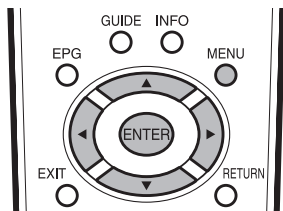

Digital settings

You can reconfigure DTV services settings automatically or manually.

- 1 Press **MENU** and the MENU screen displays.
- 2 Press **◀▶** to select "Setup"
- 3 Press **▲/▼** to select "Programme setup", and then press **ENTER**. If you have already set the password, enter it here.
 - See page 28 for setting a password.
 The "Digital setting" screen displays and then press **ENTER**.
- 4 Press **▲/▼** to select the desired menu item, and then press **ENTER**.
- 5 Press **◀▶** to select "Yes", and then press **ENTER**.

Additional search

Use this menu to add new services automatically after auto installation has been completed.

Manual search

Add new services within a specified frequency band.

- Enter the frequency using **0 - 9** numeric buttons.

Manual adjust

Configure various settings for each service using the Colour (**R**, **G**, **Y**, **B**) buttons.

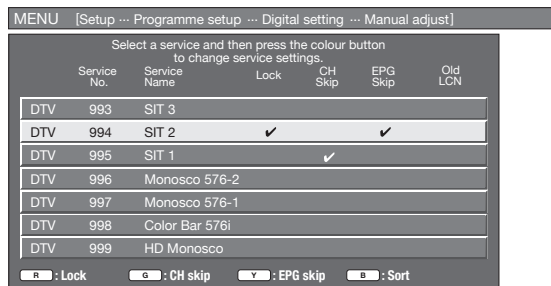

- 1 Press **▲/▼** to select the desired service.

- 2 Press the colour button on the remote control corresponding with the item you want to reconfigure.

- The **✓** mark indicates the operation is set to on. Each time the colour button is pressed, you can switch the corresponding operation on/off.

Buttons for Manual Adjust operation

Menu items	Remote control buttons	Description
Lock	R	When the service is locked, you must enter your password whenever you tune to the service.
CH Skip	G	Services with a ✓ mark are passed over when pressing ▲/▼ in the TV/remote control unit.
EPG Skip	Y	Services with a ✓ mark are passed over in the Electronic Programme Guide (EPG).
Sort	B	The item position of services can be sorted.

The item position of services can be sorted

- ① Press **▲/▼** to select the service whose item position you want to move, and then press **B**.

DTV 994	SIT 2	✓	✓
DTV 995	SIT 1		✓

- ② Press **▲/▼** to move it to the desired position, and then press **ENTER**.

DTV 994	SIT 1		✓
DTV 995	SIT 2	✓	✓

- ③ Repeat steps ① and ② until all desired service items are sorted.

Watching TV

Manual setting for each channel (Analogue)

You can set some channel items manually. They are Search, Fine (TV frequency), Colour sys., Sound sys., Label (Network name), Skip and Lock (Child lock).

- 1 Press **MENU** and the MENU screen displays.
- 2 Press **◀/▶** to select "Setup".
- 3 Press **▲/▼** to select "Programme setup", and then press **ENTER**. If you have already set the password, enter it here.
 - See page 28 for setting a password.
 The "Analogue setting" screen displays and then press **ENTER**.
- 4 Press **▲/▼** to select "Manual adjust", and then press **ENTER**.
- 5 Press **◀/▶** to select "Yes", and then press **ENTER**.

Programme Setup "Manual adjust" menu

Please select channel to be edited

01 SAT.1	02 PR07	03 KABEL	04	05
06	07	08	09	10
11	12	13	14	15
16	17	18	19	20

Next

You can select one of the following settings.

- ① **Search** (See page 23.)
- ② **Fine** (See page 23.)
- ③ **Colour sys.** (See page 23.)
- ④ **Sound sys.** (See page 24.)
- ⑤ **Label** (See page 24.)
- ⑥ **Skip** (See page 24.)
- ⑦ **Lock** (See page 24.)

Search tuning

- 1 Press **▲/▼/◀/▶** to select the channel you want to edit, and then press **ENTER**.
 - The selected channel information displays.
- 2 Press **▲/▼** to select "Search", and then press **ENTER**.

MENU [Setup ... Programme setup]	
Search	Channel frequency settings
Fine [179.25]	179.25 MHz
Colour sys. [Auto]	Next
Sound sys. [B/G]	Store
Label [SAT.1]	Cancel
Skip [Off]	
Lock [Off]	

- 3 Press **▲/▼** to select item and press **ENTER**.
 - **Next:** Search the next channel.
 - **Store:** Memorise the current display channel.
 - **Cancel:** Return to the previous screen. (The search result will not be stored.)

Fine tuning

- 1 Press **▲/▼/◀/▶** to select the channel you want to edit, and then press **ENTER**.
 - The selected channel information displays.
- 2 Press **▲/▼** to select "Fine", and then press **ENTER**.
- 3 Press **◀/▶** to adjust the frequency, and then press **ENTER**.
 - Adjust while checking the background picture as a reference.

Search	Channel frequency settings
Fine [179.25]	179.25 MHz
Colour sys. [Auto]	
Sound sys. [B/G]	
Label [SAT.1]	
Skip [Off]	
Lock [Off]	

- Instead of the method above, you can also set by directly entering the frequency number of the channel with **0-9**.
- When setting a frequency on the "Fine" screen, the last figure of the frequency needs to be "0" or "5".

EXAMPLE

- 179.25 MHz: Press **1 → 7 → 9 → 2 → 5**.
- 49.25 MHz: Press **4 → 9 → 2 → 5 → ENTER**.

Colour system

- 1 Press **▲/▼/◀/▶** to select the channel you want to edit, and then press **ENTER**.
 - The selected channel information displays.
- 2 Press **▲/▼** to select "Colour sys.", and then press **ENTER**.
 - Receivable colour systems are listed.

Colour system menu

Search	Colour system settings
Fine [179.25]	Auto
Colour sys. [Auto]	PAL
Sound sys. [B/G]	SECAM
Label [SAT.1]	
Skip [Off]	
Lock [Off]	

- 3 Press **▲/▼** to select the optimum colour system, and then press **ENTER**.

Watching TV

Manual setting for each channel (continued)

Sound system (Broadcasting system)

- 1 Press **▲/▼/◀/▶** to select the channel you want to edit, and then press **ENTER**.
 - The selected channel information displays.
- 2 Press **▲/▼** to select "Sound sys.", and then press **ENTER**.
 - Receivable sound systems (Broadcasting systems) are listed.

Sound system menu	
Search	Sound system settings
Fine [179.25]	
Colour sys. [Auto]	<input type="text" value="B/G"/>
Sound sys. [B/G]	<input type="text" value="D/K"/>
Label [SAT.1]	<input type="text" value="I"/>
Skip [Off]	
Lock [Off]	

- 3 Press **▲/▼** to select the optimum sound system, and then press **ENTER**.

Labelling channels

When a TV channel sends its Network Name, the auto installation detects the information and assigns a name to it. However, you can change individual channel names.

- 1 Press **▲/▼/◀/▶** to select the channel you want to edit, and then press **ENTER**.
 - The selected channel information displays.
- 2 Press **▲/▼** to select "Label", and then press **ENTER**.
 - The alphabet and numbers are listed.

Labelling menu	
Search	Broadcasting station name settings
Fine [179.25]	
Colour sys. [Auto]	<input type="text" value="S A T . 1"/>
Sound sys. [B/G]	
Label [SAT.1]	A B C D E F G H I J CLEAR
Skip [Off]	K L M N O P Q R S T BACK
Lock [Off]	U V W X Y Z + - . _
	0 1 2 3 4 5 6 7 8 9 END

- 3 Press **▲/▼/◀/▶** to select each character of the new name for the channel, and then press **ENTER**.
- 4 Repeat until the name is fully spelt out.
 - The name can be 5 characters or less.
 - When you want to set a channel name of less than 5 characters, select "END".

Skipping channels

Channels with "Skip" set to "On" are passed over when using **CH▲/▼** even if selected while watching the image from the TV.

- 1 Press **▲/▼/◀/▶** to select the channel you want to edit, and then press **ENTER**.
 - The selected channel information will be displayed.
- 2 Press **▲/▼** to select "Skip", and then press **ENTER**.
 - Skip menu displays.

Skip menu	
Search	Channel skip settings
Fine [179.25]	
Colour sys. [Auto]	<input type="text" value="Off"/>
Sound sys. [B/G]	<input type="text" value="On"/>
Label [SAT.1]	
Skip [Off]	
Lock [Off]	

- 3 Press **▲/▼** to set "Skip" to "On", and then press **ENTER**.

Setting the child lock

You can block the viewing of any channel.

- 1 Press **▲/▼/◀/▶** to select the channel you want to edit, and then press **ENTER**.
 - The selected channel information will be displayed.
- 2 Press **▲/▼** to select "Lock", and then press **ENTER**.
 - Child lock menu will be displayed.

Lock menu	
Search	Applies child lock to this channel
Fine [179.25]	
Colour sys. [Auto]	<input type="text" value="Off"/>
Sound sys. [B/G]	<input type="text" value="On"/>
Label [SAT.1]	
Skip [Off]	
Lock [Off]	

- 3 Press **▲/▼** to set "Lock" to "On", and then press **ENTER**.

NOTE

- See page 28 for setting a password.
- If "Lock" is set to "On" for a channel, "Child lock has been activated RETURN: Input password" is displayed when you select the channel, and the image and sound of the channel is blocked.
- When pressing **RETURN** while "Child lock has been activated RETURN: Input password" is displayed, password input menu will be displayed. Inputting the correct password lifts the child lock temporarily until the power is turned off.

Watching TV

Sorting programmes

Channel positions can be sorted freely.

- 1 Press **MENU** and the MENU screen displays.
- 2 Press **◀/▶** to select "Setup".
- 3 Press **▲/▼** to select "Programme setup", and then press **ENTER**. If you have already set the password, enter it here.
 - See page 28 for setting a password.
 The "Analogue setting" screen displays and then press **ENTER**.
- 4 Press **▲/▼** to select "Sort", and then press **ENTER**.
- 5 Press **◀/▶** to select "Yes", and then press **ENTER**.
- 6 Press **▲/▼/◀/▶** to select the channel you want to move, and then press **ENTER**.
- 7 Move it to the desired position by pressing **▲/▼/◀/▶**, and then press **ENTER**.
- 8 Repeat the steps 6 and 7 until all desired channels are sorted.

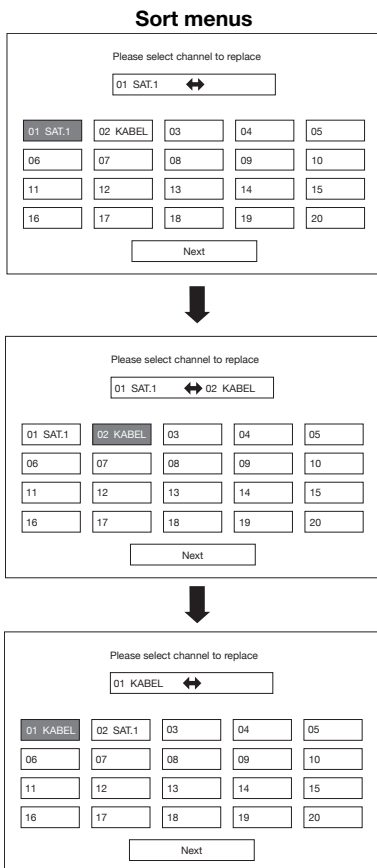

Erasing programmes

The individual programme can be erased.

- 1 Press **MENU** and the MENU screen displays.
- 2 Press **◀/▶** to select "Setup".
- 3 Press **▲/▼** to select "Programme setup", and then press **ENTER**. If you have already set the password, enter it here.
 - See page 28 for setting a password.
 The "Analogue setting" screen displays and then press **ENTER**.
- 4 Press **▲/▼** to select "Erase programme", and then press **ENTER**.
- 5 Press **◀/▶** to select "Yes", and then press **ENTER**.
- 6 Press **▲/▼/◀/▶** to select the channel you want to erase, and then press **ENTER**.
 - A message screen pops up.
- 7 Press **◀/▶** to select "Yes", and then press **ENTER** to erase the selected programme. All the subsequent programmes move up.
- 8 Repeat the steps 6 and 7 until all desired channels are erased.

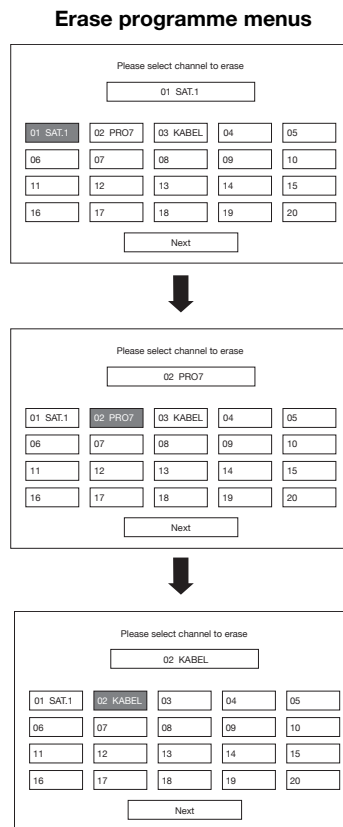

Watching TV

Useful viewing functions

Returning to the previously selected channel

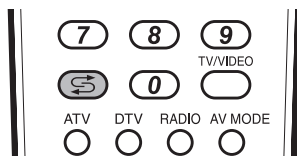

Press **↶** to switch the currently tuned channel to the previously tuned channel.
Press **↶** again to switch back to the currently tuned channel.

Press **↶** to toggle between the currently selected input source and the previously selected one.

Press **↶** to return to the previous page in TELETEXT mode.

Freezing the image

Allows you to capture and freeze one frame from a moving image that you are watching.

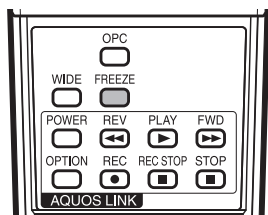

- 1 Press **FREEZE**.
 - Captures one frame from a moving image.

- 2 Press **FREEZE** again to cancel the function.

NOTE

- The still image automatically goes out after 30 minutes.

Muting the audio temporarily

Using Mute (M) on the remote control unit

M mutes the current sound output.

- 1 Press M.
 - The sound is silenced.
 - "M" is displayed while the mute function is on.

Mute



NOTE

- Within 30 minutes after pressing M, press one of the buttons below to cancel the mute.
 - VOL - /VOL +
 - M
- **Mute will be cancelled after 30 minutes. However, the TV will not suddenly output loud sound as the volume level will be set to 0 automatically. Increase the volume level by pressing VOL +.**

- 2 Press M again within 30 minutes to cancel the mute.
 - Before 30 minutes, the volume level returns to the previous setting.

Outputting only audio

When listening to music from a music programme, you can set the display off and enjoy audio only.

- 1 Press **MENU** and the MENU screen displays.
- 2 Press **◀▶** to select "Option".
- 3 Press **▲/▼** to select "Audio only", and then press **ENTER**.
- 4 Press **◀▶** to select "On", and then press **ENTER**.

Selected item	Description
On	Audio is output without screen image.
Off	Both screen images and audio are output.

NOTE

- When you make operations that change the picture on the TV such as by changing the input source, the Audio only function is set to "Off".

Watching TV

Switching the analogue audio format

You can switch between multiple audio modes when watching a multiple audio or stereo broadcast programme.

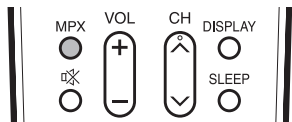

In the NICAM TV broadcasts

When receiving a stereo signal

Each time you press **MPX**, the mode switches between NICAM STEREO and MONO.

Stereo mode

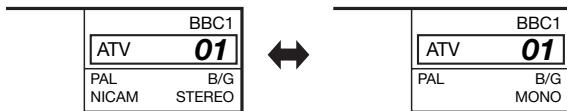

When receiving a bilingual signal

Each time you press **MPX**, the mode switches among NICAM CH A, NICAM CH B, NICAM CH AB and MONO.

Bilingual mode

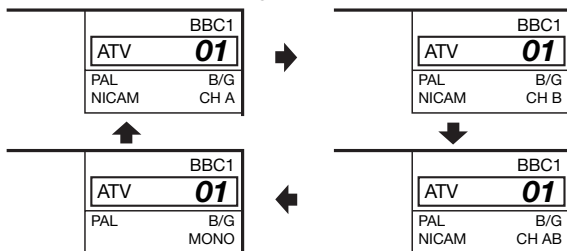

When receiving a monaural signal

Each time you press **MPX**, the mode switches between NICAM MONO and MONO.

Monaural mode

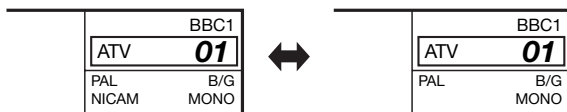

In the TV mode of A2 TV broadcasts

When receiving a stereo signal

Each time you press **MPX**, the mode switches between STEREO and MONO.

Stereo mode

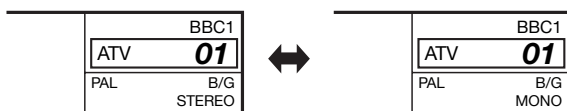

When receiving a bilingual signal

Each time you press **MPX**, the mode switches among CH A, CH B and CH AB.

Bilingual mode

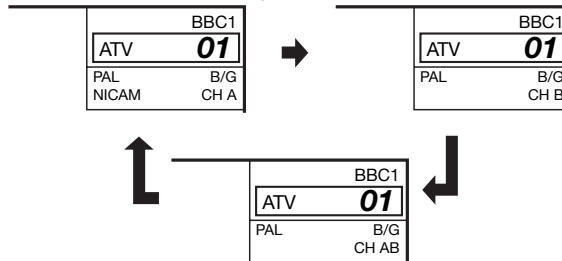

When receiving a monaural signal

When you press **MPX**, "MONO" displays.

Monaural mode

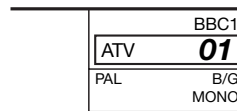

NOTE

- "BBC2", "99" and "PAL" are tentative network name, channel and colour system.

Switching the digital audio format

If multi sound modes are received, each time you press **MPX** the mode switches as follows.

(Example)

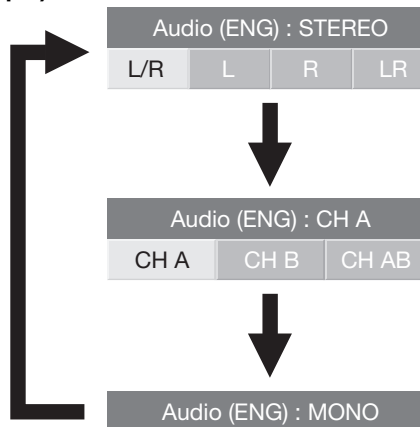

Press **◀▶** to select L or R sound when the STEREO or DUAL MONO screen is displayed.

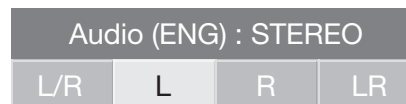

NOTE

- The sound mode screen disappears in 6 seconds.
- Selectable items vary depending on the received broadcasts.

Watching TV

Password setting for the child lock (for TV input mode)

Allows you to use a password to protect certain settings from being accidentally changed.

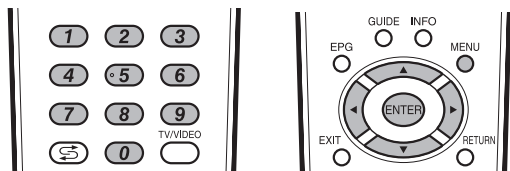

Setting a password

Register a 4-digit password number to use the Child lock function.

1 Press **MENU** and the MENU screen displays.

2 Press **◀▶** to select "Setup".

3 Press **▲▼** to select "Child lock", and then press **ENTER**.

4 If you have already set the password, enter it here.

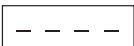

5 Press **▲▼** to select "Change password", and then press **ENTER**.

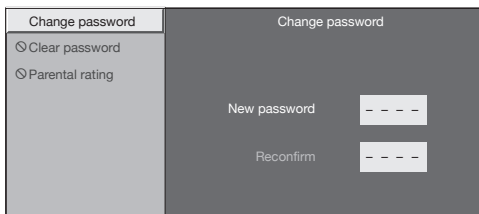

6 Enter the 4-digit number as a password using **0-9**.

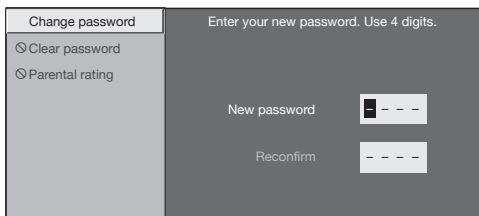

7 Enter the same 4-digit number as in step 6 to confirm.

- "The new password was registered" displays.

NOTE

- To view a locked channel (Lock setting in Programme setup "Manual adjust" is set to "On"), you must enter a password. (See page 24.) When you select a locked channel, a password prompt message pops up. Press **RETURN** to display the password input window.

Clearing the password

Allows you to clear your password.

1 Repeat steps 1 to 3 in **Setting a password**.

2 Enter the password.

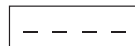

3 Press **▲▼** to select "Clear password", and then press **ENTER**.

4 Press **◀▶** to select "Yes", and then press **ENTER**.

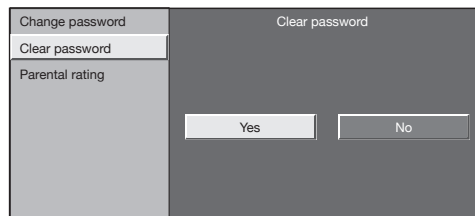

NOTE

- **As a precautionary measure, make a note of your password and keep it in a familiar place. If you lose or forget your password, initialise the TV to return all settings except for the TV channel settings to factory preset values. (See page 70.)**
- This function is only available for TV input mode.
- To relock a channel which has been temporarily unlocked by inputting the correct password, turn power off and then on again.

Watching TV

Parental rate

This function allows TV channels to be restricted. It prevents children from watching violent or sexual scenes that may be considered inappropriate.

- 1 Repeat steps 1 to 3 in **Setting a password**.
- 2 Press **▲/▼** to select "Parental rating", and then press **ENTER**.
- 3 Press **▲/▼** to select your desired rating, and then press **ENTER**.

Selected item	Description
General and above (G)	Content is not offensive to most viewers.
Parental guidance and above (PG)	Content is such that parents may not want their children to view the programme.
Mature and above (M)	Mature audience only. This programme is specifically designed to be viewed by adults and therefore may be unsuitable for children under 15.
Mature adult and above (MA)	Mature adult only. This programme is specifically designed to be viewed by adults and therefore may be unsuitable for children under 15.
Adult violence and above (AV)	Not for children under age 15. Strong elements of sex and/or violence.
Restricted and above (R)	Not for children under age 18. Strong elements of sex and/or violence.
No block (-)	Cancel the blocking.

Programme title display

This function allows you to display programme information on the screen including the title and airtime by tuning a channel.

- 1 Press **MENU** and the MENU screen displays.
- 2 Press **◀/▶** to select "Option".
- 3 Press **▲/▼** to select "Programme title display", and then press **ENTER**.
- 4 Press **◀/▶** to select "Yes", and then press **ENTER**.

NOTE

- The Programme title display function is only available for the DTV mode.

Key lock

This function allows you to lock the buttons on the TV or remote control in order to prohibit children from changing the channel or volume.

- 1 Press **MENU** and the MENU screen displays.
- 2 Press **◀/▶** to select "Option".
- 3 Press **▲/▼** to select "Key lock", and then press **ENTER**.
- 4 Press **▲/▼** to select "RC control lock" or "Button control lock", and then press **ENTER**.

Selected item	Description
Off	Unlock the buttons.
RC control lock	Lock all buttons on the remote control.
Button control lock	Lock the TV buttons except the power switch.

NOTE

- You cannot set both "RC control lock" and "Button control lock" at the same time.

■ Cancelling the lock

To cancel "RC control lock" follow the below steps using the TV control panel buttons on the TV.

- 1 Press **MENU** on the TV and **VOL+/VOL-** to select "Option".
- 2 Press **CH ▲/▼** to select "Key lock", and then press **TV/VIDEO**.
- 3 Press **CH ▲/▼** to select "Off", and then press **TV/VIDEO**.

NOTE

- See page 17 for the functions of the TV control panel buttons.
- **To cancel "Button control lock", use the remote control.**

Watching TV

Energy conservation settings

Auto power-off at a designated time

This function is conveniently used when, for instance, going to bed while watching TV.

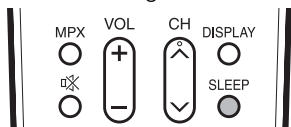

- 1 Press **SLEEP**.
 - Remaining time displays when sleep timer has been set.

Sleep Timer: Remain 2 hr. 00 min.

- 2 Each time you press **SLEEP**, the remaining time switches as shown below.

0 hr. 30 min. → 1 hr. 00 min. → 1 hr. 30 min.
 ↑ Off ← 2 hr. 30 min. ← 2 hr. 00 min.

NOTE

- When the time has been set, countdown automatically starts.
- Five minutes before the preset of time expires, the remaining time displays each minute.
- Select "Off" by pressing **SLEEP** to cancel the sleep timer.

ECO picture control

This function automatically detects the image source and decreases the power consumption while keeping the brightness of the image unchanged.

- 1 Press **MENU** and the MENU screen displays.
- 2 Press **◀/▶** to select "ECO".
 - ECO menu displays.
- 3 Press **▲/▼** to select "ECO picture control", and then press **ENTER**.
- 4 Press **◀/▶** to select "On" or "Off", and then press **ENTER**.

NOTE

- This function does not work when "AV MODE" is set to "DYNAMIC (Fixed)" or "AUTO".
- This function does not work when "Energy save" is set to "Standard" or "Advanced".

Energy save

This function enables you to automatically reduce the backlight brightness in order to decrease the power consumption and increase the backlight life span.

- 1 Press **MENU** and the MENU screen displays.
- 2 Press **◀/▶** to select "ECO".
 - ECO menu displays.

- 3 Press **▲/▼** to select "Energy save", and then press **ENTER**.
- 4 Press **▲/▼** to select "Standard" or "Advanced", and then press **ENTER**.

Selected item	Description
Standard	Reduces the backlight brightness by 25%.
Advanced	Reduces the backlight brightness by 50%.
Off	The backlight brightness is the same value of your settings in the selected "AV MODE".

Auto power-off after the end of broadcast

You can set the TV to automatically power off in about 15 minutes after the TV goes into a state of receiving no programme signals, such as the end of a broadcast day.

- 1 Press **MENU** and the MENU screen displays.
- 2 Press **◀/▶** to select "ECO".
 - ECO menu displays.
- 3 Press **▲/▼** to select "No signal off", and then press **ENTER**.
- 4 Press **◀/▶** to select "Enable", and then press **ENTER**.
 - Five minutes before the power shuts down, the remaining time displays every minute.

NOTE

- "Disable" is the factory preset value.
- When a TV programme finishes, this function may not operate.

Auto power-off when there are no operations performed

You can set the TV to automatically power off when no TV operation is performed for more than 3 hours.

- 1 Press **MENU** and the MENU screen displays.
- 2 Press **◀/▶** to select "ECO".
 - ECO menu displays.
- 3 Press **▲/▼** to select "No operation off", and then press **ENTER**.
- 4 Press **▲/▼** to select "30min." or "3hr.", and then press **ENTER**.
 - Five minutes before the power shuts down, the remaining time displays every minute.

NOTE

- "Disable" is the factory preset value.

Watching TV

Quick start

You can reduce the TV's start-up time after turning on the power with the remote control unit.

- 1 Press **MENU** and the MENU screen displays.
- 2 Press **◀/▶** to select "Setup".
- 3 Press **▲/▼** to select "Quick start", and then press **ENTER**.
- 4 Press **◀/▶** to select "On" or "Off", and then press **ENTER**.

Selected item	Description
On	The TV quickly starts up from standby, 19 W or more of power consumption is required during standby.
Off	Power consumption is less than 1 W.

Picture size settings

Selecting the Wide Screen Signalling (WSS) picture size automatically

WSS allows a television to switch automatically among the different screen formats.

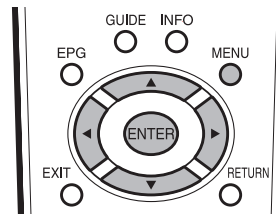

- 1 Press **MENU** and the MENU screen displays.
- 2 Press **◀/▶** to select "Setup".
- 3 Press **▲/▼** to select "WSS", and then press **ENTER**.
- 4 Press **◀/▶** to select "On" or "Off", and then press **ENTER**.

NOTE

- Try to set WIDE mode if an image does not switch to the correct screen format. When the broadcast signal contains no WSS information, the function will not work even if enabled.

Selecting the Wide Screen Signalling (WSS) picture size manually

The WSS signal has 4:3 auto-switching that allows you to select between Panorama and Normal.

- 1 Press **MENU** and the MENU screen displays.
- 2 Press **◀/▶** to select "Setup".
- 3 Press **▲/▼** to select "4:3 mode", and then press **ENTER**.
- 4 Press **◀/▶** to select "Panorama" or "Normal", and then press **ENTER**.

WSS signal 4:3 screen

4:3 mode "Panorama"



4:3 mode "Normal"



Selected item	Description
Panorama	Wide image without side bars
Normal	Normal range keeping 4:3 or 16:9 aspect ratio

Watching TV

Selecting the picture size manually

Manual Selection

You can select different picture sizes that account for the kind of each picture.

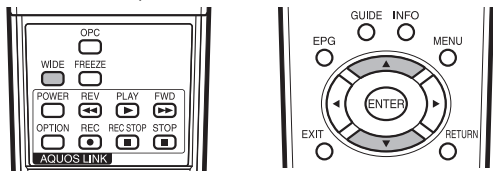

1

Press **WIDE**.

- The WIDE MODE menu displays.
- The menu lists the wide mode options selectable for the type of video signal currently received.

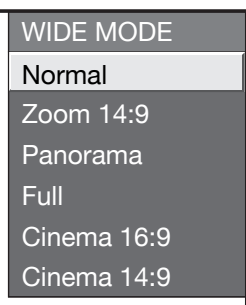

2

Press **WIDE** or **▲/▼** while the WIDE MODE menu displays on the screen.

- As you toggle down the options, each mode is immediately reflected on the TV.

Auto Selection

If you set "WSS" and "4:3 mode" in the Setup menu on page 31, the optimum WIDE mode is automatically chosen for every broadcast containing the WSS information.

"WSS" menu

To enable Auto Selection, set "WSS" in the Setup menu to "On". (See page 31.)

"4:3 Mode" menu

To set the type of the wide screen, select "Panorama" or "Normal" in the 4:3 Mode menu. (See page 31.)

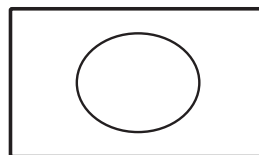

4:3 Mode set to "Panorama"

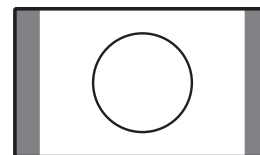

4:3 Mode set to "Normal"

NOTE

- If the broadcast signal contains no WSS information, Auto Selection will not function even when the WSS option is enabled.

Selected item	Description
Normal	For 4:3 "standard" pictures. A side bar appears on each side.
Zoom 14:9	For 14:9 letterbox pictures. A thin side bar appears on each side, and you may also see bars on the top and bottom with some programmes.
Panorama	In this mode the picture is progressively stretched toward each side of the screen.
Full	For 16:9 squeeze pictures.
Cinema 16:9	For 16:9 letterbox pictures. Bars may appear on the top and bottom with some programmes.
Cinema 14:9	For 14:9 letterbox pictures. Bars may appear on the top and bottom with some programmes.
Dot by Dot	Displays an image with the same number of pixels on the screen (only when receiving a 1080i/1080p signal).
Underscan	Display with an Underscan image only when receiving a 720p signal. Display with the High-Definition image adjusted optimally. Noise may appear on the edge of the screen with some programmes.

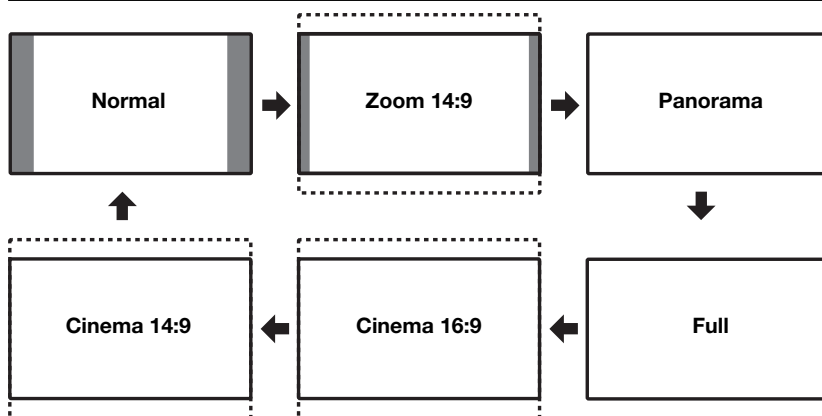

NOTE

- Some picture sizes may not be displayable depending on the input signal.

Watching TV

Selecting a preset AV MODE

The AV MODE function enables you to select appropriate settings for audio and video to account for the system environment which can vary due to factors like room brightness, type of programme watched or the type of image input from external equipment.

Using AV MODE on the remote control unit

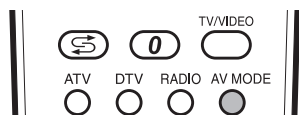

- 1 Press **AV MODE**.
 - Present AV MODE displays.
- 2 Press **AV MODE** again before the mode displayed on the screen disappears.
 - The mode changes as shown below.

When the input source is TV, INPUT4, 5 or 6 terminal (Example)

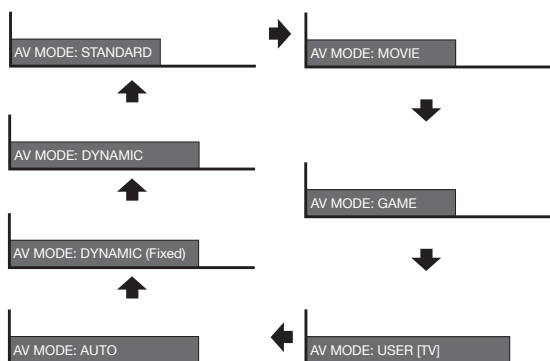

When the input source is INPUT 1, 2, 3 or 7 terminal (Example)

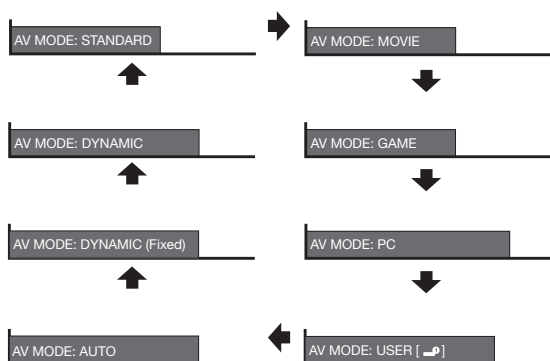

Selected item	Description
STANDARD	For a highly defined image in a normally bright room.
MOVIE	For a movie.
GAME	Lowers image brightness for easier viewing.
PC*	For PC. (Available only when inputting an HDMI or RGB signal.)
USER	Allows the user to customise settings as desired. You can set the mode for each input source.
AUTO	The TV automatically sets the appropriate selection from the "AV MODE" menu depending on the lighting conditions and the type of programme watched.
DYNAMIC (Fixed)	Changes the image and sound settings to the factory preset values. No adjustments are allowed.
DYNAMIC	For a clear-cut image emphasising high contrast for sports viewing.

NOTE

- The item marked with * is available only when selecting "INPUT1", "INPUT2", "INPUT3" or "INPUT7" from the INPUT SOURCE menu.
- If you select "AUTO", some selections in the "AV MODE" menu may not be automatically set.

Watching TV

Manual picture settings

Picture adjustment

You can adjust the picture to your preference. Follow the steps to adjust the picture.

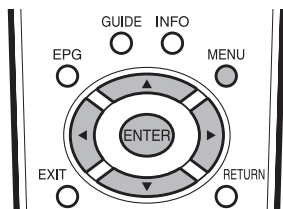

1 Press **MENU** and the MENU screen displays.

2 Press **◀▶** to select "Picture".



3 Press **▲▼** to select the desired menu item. Press **ENTER** to proceed if necessary.

4 Press **▲▼** or **◀▶** to select the desired item or adjust the item to the desired level. Press **ENTER** if necessary.

NOTE

- For resetting all adjustment items to factory preset values, press **▲▼** to select "Reset", press **ENTER**, press **◀▶** to select "Yes", and then press **ENTER**.
- Select "Advanced" and then press **ENTER** to set "C.M.S.-hue", "C.M.S.-saturation", "C.M.S.-value", "Colour temp.", "Fine motion advanced", "Film mode", "Active contrast", "DNR", "3D-Y/C", "Monochrome" or "Range of OPC". See page 35 and 36.

Selected item	◀ button	▶ button
OPC	Sets whether or not the screen brightness is automatically adjusted according to the lighting condition in the room. (OPC setting: See this page.)	
Backlight	The screen dims	The screen brightens
Contrast	For less contrast	For more contrast
Brightness	For less brightness	For more brightness
Colour	For less colour intensity	For more colour intensity
Tint	Skin tones become purplish	Skin tones become greenish
Sharpness	For less sharpness	For more sharpness
Advanced	For finer picture adjustments. (See page 35 and 36.)	
Reset	Resets all picture adjustment items to the factory preset values.	

OPC (Optical Picture Control) setting

You can set the TV to automatically adjust the screen to suitable backlight brightness according to the lighting conditions.

Using OPC on the remote control unit

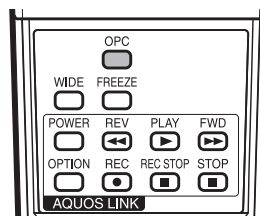

Press **OPC** to switch the OPC function on or off.

Using OPC on the menu screen

Selected item	Description
Off	The brightness is fixed at the value set in "Backlight" (See this page).
On	Automatically adjusts
On: Display	Displays the OPC effect on the screen while adjusting the brightness of the screen.

NOTE

- Make sure no object obstructs the OPC sensor, which could affect its ability to sense surrounding light.

Watching TV

Advanced picture settings

The advanced settings enable you to set the picture adjustment in more detail. There are twelve options you can choose from.

1 Press **MENU** and the MENU screen displays.

2 Press **◀/▶** to select "Picture".

3 Press **▲/▼** to select "Advanced", and then press **ENTER**.

4 Press **▲/▼** to select the desired menu, and then press **ENTER**.

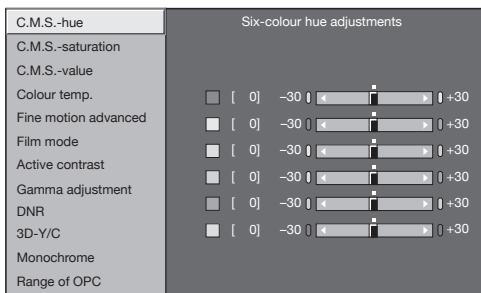

5 Press **▲/▼** or **◀/▶** to select the desired level, and then press **ENTER**.

■ C.M.S.-hue

This function adjusts the hue of a selected colour using a six-colour adjustment system.

■ C.M.S.-saturation

This function increases or decreases the saturation of a selected colour using a six-colour adjustment system.

■ C.M.S.-value

This function makes the image brighter or darker depending on the value of the setting.

■ Colour temp. (Colour temperature)

Adjusts the colour temperature to give the best white image.

Selected item	Description
High Mid-High Middle Mid-Low Low	White with bluish tone ↑ ↓ White with reddish tone
R/G/B Gain (LO), R/G/B Gain (HI)	Adjusts the white balance by changing the value of each item.

■ Fine motion advanced

Use Fine motion advanced to view fast-action images more clearly.

Selected item	Description
On	For obtaining a clear image
Off	No adjustment

■ Film mode

Automatically detects a film-based source (originally encoded at 24/25 frames/second, depending on the vertical frequency), analyses it then recreates each still film frame for high-definition picture quality.

Selected item	Description
Advanced (High)	Display moving picture more smoothly with high quality.
Advanced (Low)	Display moving picture smoothly with high quality.
Standard	Display every picture frame in equal time, feeling like watching in cinema.
Off	Film mode off.

NOTE

- Film mode is not selectable depending on the input signal type.

■ Active contrast

Automatically adjusts the contrast of an image according to the scene.

■ Gamma adjustment

Adjust mid-level brightness. The adjustment range of the gamma can be set to a maximum of +2 and a minimum of -2 by pressing **◀** or **▶**.

■ DNR (Digital Noise Reduction)

Reduces noise on screen and produces a clearer video image. ("Auto", "High", "Middle", "Low", "Off").

■ 3D-Y/C

Provides high quality images with minimal dot crawl and cross colour noise.

Selected item	Description
Standard	Normal adjustment
Fast	Set the optimum image quality for fast-moving images.
Slow	Set the optimum image quality for slow-moving images.

NOTE

- 3D-Y/C is not selectable depending on the input signal type.
- 3D-Y/C may not operate depending on the input signal type or noisy input signal.

■ Monochrome

For viewing images in monochrome.

Watching TV

Range of OPC

The brightness level range of the OPC sensor's automatic adjustments can be set according to your preferences. The adjustment range of the OPC sensor can be set to a maximum of +16 and a minimum of -16.

Selected item	Description
Max.	-15 through +16
Min.	-16 through +15

NOTE

- This function is available only when the OPC setting is set to On or On: Display.
- The maximum setting cannot be set to a smaller number than the minimum setting.
- The minimum setting cannot be set to a bigger number than the maximum setting.
- The maximum and minimum settings cannot be set to the same number.
- Depending on the brightness of the surrounding light, the OPC sensor might not operate if the adjustment range is small.

Other picture settings

Adjusting the image position

For adjusting a picture's horizontal and vertical position.

- 1 Press **MENU** and the MENU screen displays.
- 2 Press **◀▶** to select "Setup".
- 3 Press **▲▼** to select "Position", and then press **ENTER**.
- 4 Press **▲▼** to select "H-pos." or "V-pos."

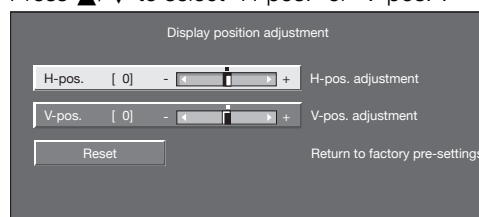

Selected item	Description
H-pos.	Centres the image by moving it to the left or right.
V-pos.	Centres the image by moving it up or down.

- 5 Press **◀▶** to adjust the item to your desired position.

NOTE

- For resetting all adjustment items to the factory preset values, press **▲▼** to select "Reset", and then press **ENTER**.
- **Adjustments are stored separately according to input source.**
- Depending on the input signal type or "WIDE MODE" setting, a position setting may not be available.

Game play time

This function displays the elapsed game time so you do not lose track of the time.

To display the elapsed time, select "GAME" under "AV MODE" for the input mode of the terminal connected to the game console before starting the game.

- 1 Press **MENU** and the MENU screen displays.
- 2 Press **◀▶** to select "Option".
- 3 Press **▲▼** to select "Game play time", and then press **ENTER**.
- 4 Press **◀▶** to select "On", and then press **ENTER**.

Selected item	Description
On	The elapsed time is displayed every 30 minutes when you switch to GAME mode in external input mode.
Off	No adjustment

Watching TV

Indicating time on the screen

Time display

This function allows you to display the clock time on the lower right screen.

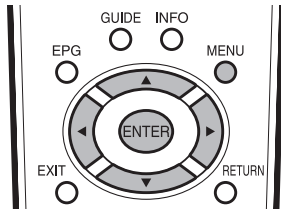

1 Press **MENU** and the MENU screen displays.

2 Press **◀/▶** to select "Option".

3 Press **▲/▼** to select "Time display" and then press **ENTER**.

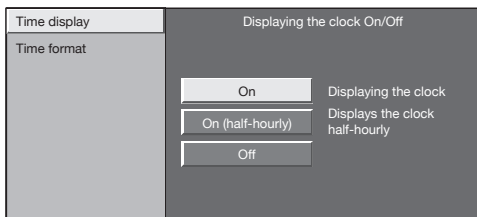

4 Press **▲/▼** to select "Time display" and then press **ENTER**.

5 Press **▲/▼** to select "On" or "On (half-hourly)" and then press **ENTER**.

Selected item	Description
On	Display the clock time.
On (half-hourly)	Display the clock time in 30 minutes increments.
Off	Hide the clock time.

Time format

You can select the time format (either 24HR or AM/PM) for the clock time.

1 Press **MENU** and the MENU screen displays.

2 Press **◀/▶** to select "Option".

3 Press **▲/▼** to select "Time display" and then press **ENTER**.

4 Press **▲/▼** to select "Time format" and then press **ENTER**.

5 Press **◀/▶** to select the desired time format, and then press **ENTER**.

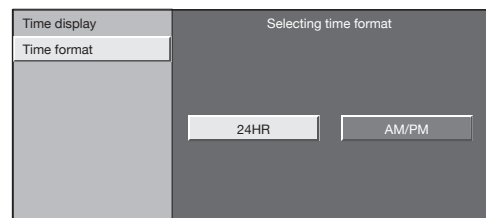

Watching TV

Audio adjustment

You can adjust the audio of the selected AV mode.

1 Press **MENU** and the MENU screen displays.

2 Press **◀/▶** to select "Audio".

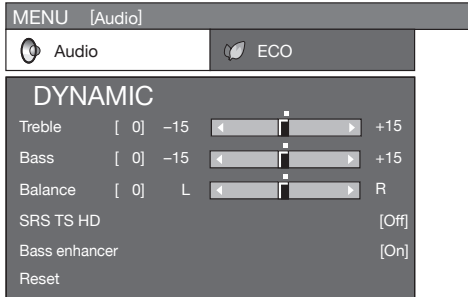

3 Press **▲/▼** to select the desired menu item. Press **ENTER** to proceed if necessary.

4 Press **▲/▼** or **◀/▶** to select the desired item or adjust the item to the desired level. Press **ENTER** if necessary.

Selected item	◀button	▶button
Treble	For weaker treble	For stronger treble
Bass	For weaker bass	For stronger bass
Balance	Increase audio from the left speaker	Increase audio from the right speaker

NOTE

- For resetting all adjustment items to the factory preset values, press **▲/▼** to select "Reset", press **ENTER**, press **◀/▶** to select "Yes", and then press **ENTER**.

SRS TruSurround (TS) HD

You can enjoy SRS TruSurround HD sound, the same as you were in movie theatre.

1 Repeat steps 1 to 2 in **Audio adjustment**.

2 Press **▲/▼** to select "SRS TS HD", and then press **ENTER**.

3 Press **◀/▶** to select "On".

Selected item	Description
On	TruSurround HD creates a high quality surround sound experience, when watching DVD movies and TV programmes broadcast in surround sound.
Off	Outputs the normal sound.

Bass enhancer

This function allows you to enjoy bass-enhanced sound.

1 Repeat steps 1 to 2 in **Audio adjustment**.

2 Press **▲/▼** to select "Bass enhancer", and then press **ENTER**.

3 Press **◀/▶** to select "On".

Selected item	Description
On	Bass enhancer function is on.
Off	Outputs the normal sound.

Output volume select

Allows you to select what controls the audio output.

1 Press **MENU** and the MENU screen displays.

2 Press **◀/▶** to select "Option".

3 Press **▲/▼** to select "Output volume select", and then press **ENTER**.

4 Press **◀/▶** to select "Fixed" or "Variable", and then press **ENTER**.

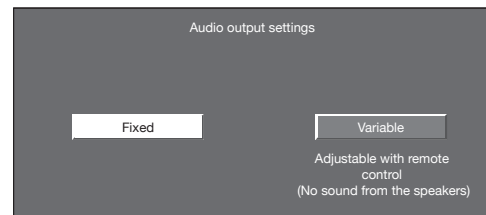

Selected item	Description
Fixed	<ul style="list-style-type: none"> Sound via speakers is adjusted with VOL +/- on the remote control unit or the TV. Sound via the MONITOR OUT terminal is not adjustable and constantly outputs.
Variable	<ul style="list-style-type: none"> Sound via the MONITOR OUT terminal is adjusted with VOL +/- on the remote control unit or the TV. Sound via speakers is muted.

Watching TV

Automatic volume adjustment

Different sound sources sometimes do not have the same volume level, such as a programme and its commercial breaks. The Automatic volume control (Auto volume) reduces this problem by equalizing levels.

- 1 Press **MENU** and the MENU screen displays.
- 2 Press **◀/▶** to select "Option".
- 3 Press **▲/▼** to select "Auto volume", and then press **ENTER**.
- 4 Press **◀/▶** to select "On", and then press **ENTER**.

Clear voice

This function emphasises speech against background noise for greater intelligibility.

- 1 Press **MENU** and the MENU screen displays.
- 2 Press **◀/▶** to select "Option".
- 3 Press **▲/▼** to select "Clear voice", and then press **ENTER**.
- 4 Press **◀/▶** to select "On", and then press **ENTER**.

Digital audio output

This function allows you to select your favourite audio output system.

- 1 Press **MENU** and the MENU screen displays.
- 2 Press **◀/▶** to select "Option".
- 3 Press **▲/▼** to select "Digital audio output", and then press **ENTER**.

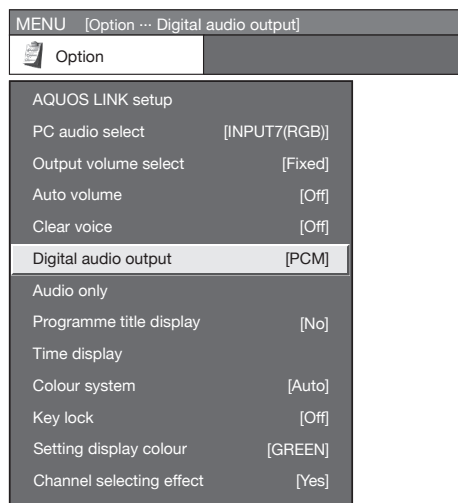

- 4 Press **▲/▼** to select your desired output system, and then press **ENTER**.

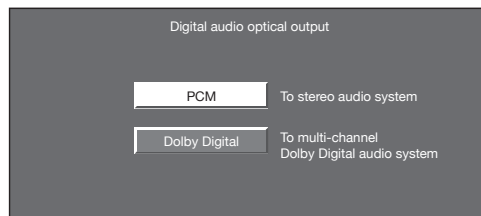

Selected item	Description
PCM	The optical output format is normally in PCM.
Dolby Digital	Dolby Digital audio will be output when there is a Dolby Digital audio signal. The output will be in PCM when there is no Dolby Digital audio signal.

Watching TV

Using Digital Audio Output

It is possible to output audio through the DIGITAL AUDIO OUTPUT terminal. PCM audio outputs from the terminal.

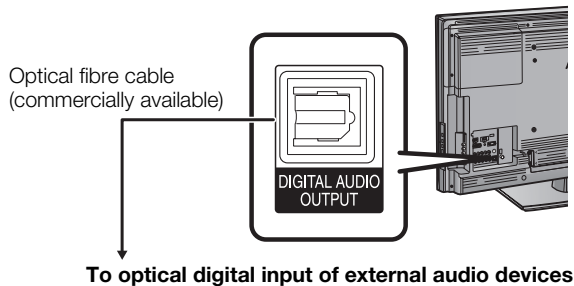

NOTE

- The DIGITAL AUDIO OUTPUT terminal usually outputs the same audio from the speakers. (The audio of the content you are viewing is output from the terminal.)
- The DIGITAL AUDIO OUTPUT terminal does not output some signals, depending on devices and software.

Programme Guide

You can check the current schedule of DTV events and view detailed information about current events.

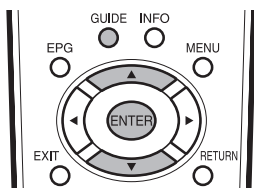

1 Press **GUIDE** to display the programme guide list.

2 Press **▲/▼** to display your desired programme, and then press **ENTER**.

- When you press **ENTER**, the TV jumps to the channel.

CH LIST [DTV -TV]		[Mon]19/6 9:29
002	ABC TV Sydney	9:23 - 9:29
	Global Grover	
▲ 002	ABC TV Sydney	Global Grover
003	SBS	
004	FTV Guide	
009	NINE DIGITAL	
010	TEN DIGITAL	
011	TEN Guide	
012	TEN HD	
020	ABC HDTV	Global Grover
021	ABC 2	ABC Asia Pacific News
022	ABC TV	Global Grover
030	SBS HD	
▼ 031	SBS 2	

Info

While watching DTV you can check the extended programme information on the screen using **INFO** on the remote control.

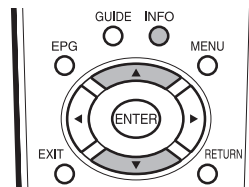

ABC TV Sydney

Dorothy The Dinosaur

15:23 - 15:30

Programme Info.

Dorothy's friends chat over Rosy Tea before admiring her beautiful Rose Garden, with Wags the Dog, Henry the Octopus and Captain Feathersword, and four new fairy friends, Clare, Larissa, Lucia and little

- If there is more information, pressing **▲/▼** allows you to go to the next page or return to the previous page.
- You can cancel this info by pressing **INFO** again.

Watching TV

ATV (Analogue)/DTV/RADIO buttons

Use the following buttons on the remote control to operate the menu.

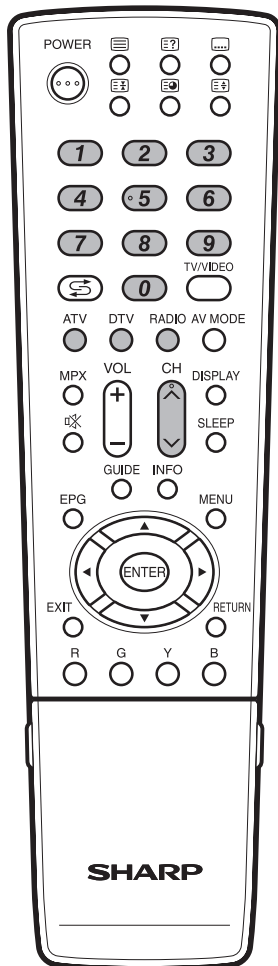

ATV: Press to switch to analogue mode. After switching from DTV, radio or external input mode to analogue mode, the TV jumps to the most recently viewed analogue channel.

DTV: Press to switch to DTV mode. After switching from analogue, radio or external input mode to DTV mode, the TV jumps to the most recently viewed DTV channel.

RADIO: Press to switch to radio mode. After switching from DTV to radio mode, the TV jumps to the most recently tuned radio channel. (DTV mode only)

When you watch the TV for the first time

When the TV powers on for the first time after purchase, perform the auto installation.

ATV (Analogue TV)

You can run the auto installation to set channels automatically.

- 1 To watch the analogue TV, select "Auto installation" from Setup menu. (See page 20.)
- 2 After setting the channels, you can select a channel using **CH** \wedge/\vee or **0 - 9** on the remote control unit. (See page 21.)

DTV

When the TV accesses to DTV mode for the first time, you need to run the auto search. To scan all available services in your area, follow the procedures below.

- 1 To watch DTV broadcasts, select "Digital search" from auto installation menu. (See page 11.)
- 2 After setting the channels, you can select a channel using **CH** \wedge/\vee or **0 - 9** on the remote control unit. (See page 21.)

Watching TV

EPG

What is an EPG?

An “EPG (Electronic Programme Guide)” is a programme schedule, which is displayed on the TV screen. The EPG is broadcasted together with DTV. The TV screen shows the EPG when the viewer presses **EPG** on the remote control, provided that the TV is receiving the digital broadcasting signal. The EPG enables you to search for a programme, do timer recording or view the programme schedule in detail.

EPG display settings

EPG (Electronic Programme Guide) is a programme list that is displayed on the screen. With the EPG, you can check the schedule of DTV/RADIO/DATA, view detailed information about them, tune to an event currently on-air and set a timer for future events.

1 Press **MENU** and the MENU screen displays.

2 Press **◀▶** to select “Digital setup”.

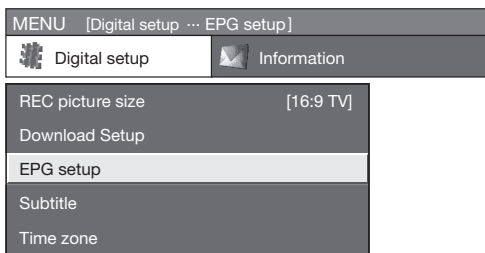

3 Press **▲/▼** to select “EPG setup”, and then press **ENTER**.

4 Press **▲/▼** or **◀▶** to select the desired item or adjust the item to the desired level. Press **ENTER** if necessary.

EPG setup (setting for receiving EPG data)

EPG setup must be selected to “YES” to enable automatic capturing of data for all available channels while the TV set is in standby mode. If EPG setup is set to “NO”, only EPG data for the current channel will be updated.

Selecting EPG setup to “YES” will result in higher power consumption*.

Selecting EPG setup to “NO” will save power consumption.

NOTE

* Approximately 19W for 15-30 minutes (depending on number of channels tuned) after power off from remote control.

- EPG data will not update if the TV is turned off from the mains power switch.

Display range setup

The Display range setup allows you to select three types of time spans for display on the screen.

Selected item	Description
Mode1 (Wide angle)	Display six hours of programme information.
Mode2 (Zoom)	Display three hours of programme information.
Mode3 (Vertical angle)	Change to the EPG display format with a vertical time span.

Genre icon setup

You can grey out or place a mark on desired genres and smoothly search for programmes you frequently watch.

Genre icon list

Icon	Genre	Icon	Genre
	Movie		Arts/Culture
	News		Current affairs
	Entertainment		Education/Information
	Sport		Information
	Children's		Comedy
	Music		Drama

NOTE

- You can easily distinguish the Genre icons by darkening or lightening the icon's shade.

Time zone

This function enables you to select your local time zone.

1 Press **MENU** and the MENU screen displays.

2 Press **◀▶** to select “Digital setup”.

3 Press **▲/▼** to select “Time zone”, and then press **ENTER**.

4 Press **▲/▼** to select the desired time zone and then press **ENTER**.

- This function lets you select the right time zone in case the time displayed in the EPG does not match the local time of your area.

Watching TV

Selecting a programme using EPG

Basic Operation

Display the EPG screen

Press **EPG**.

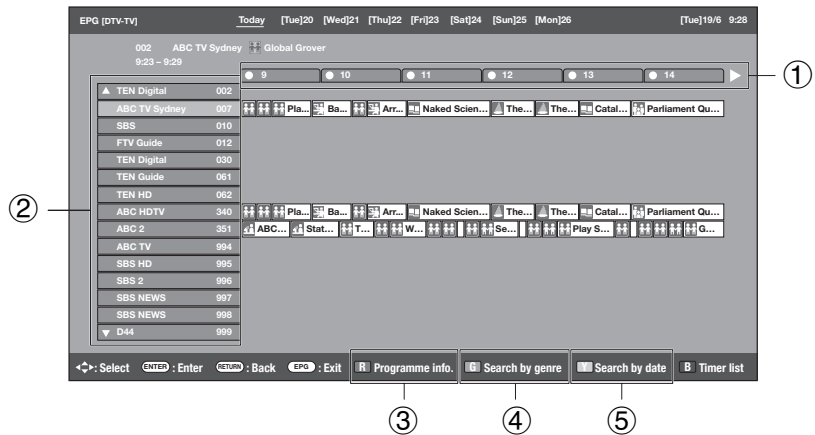
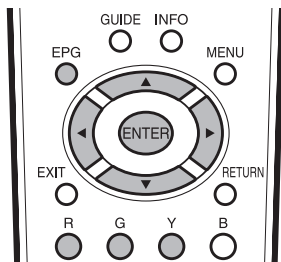

Display the EPG screen

1 Press ◀/▶ to select the time span you want to search.

- Continue to press ▶ to display programmes in the next time span.

2 Press ▲/▼ to select the desired programme.

- If ▲ or ▼ are displayed on the left of the services, continue to press ▲/▼ to display next or previous screen.

Close the EPG screen

Press **EPG** again.

Selecting a programme

3 Check programme information

1 Press ▲/▼/◀/▶ to select the programme you want to check.

2 Press **R**.

Programme information

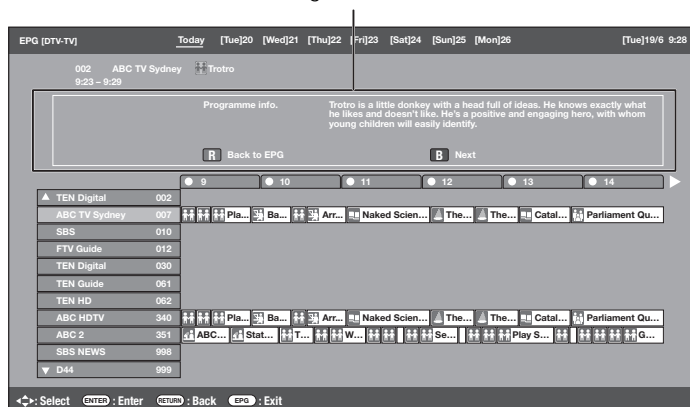

3 Press **ENTER** to tune to the selected programme.

Watching TV

④ Search a programme in a category

- 1 Press **G**.
- 2 Press **▲/▼** to select the desired genre, and then press **ENTER**.
- 3 Press **▲/▼** to select a programme you want to watch, and then press **ENTER**.

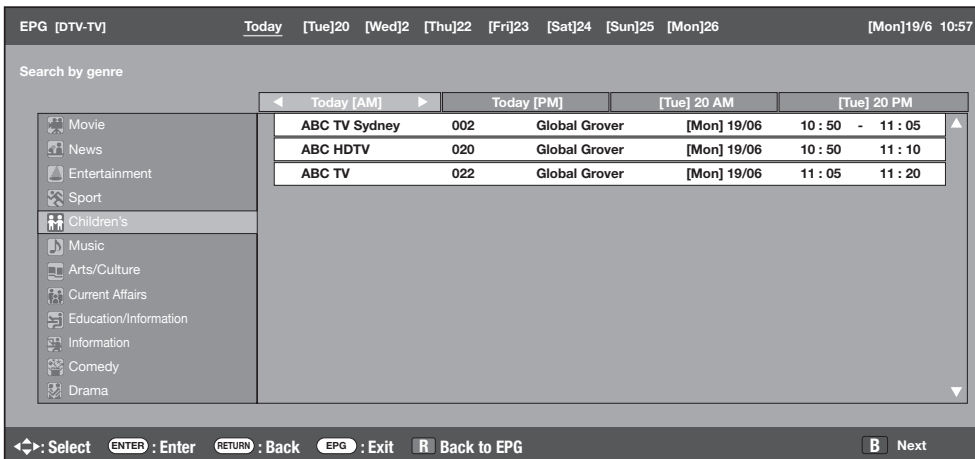

⑤ Search for a programme by date/time

- 1 Press **Y**.
- 2 Press **◀/▶** to select the desired time span and then press **ENTER**.



- 3 Press **▲/▼** to select the desired programme, and then press **ENTER**.

NOTE

- When you select a programme outside of the current time span, the timer setting screen displays. (Page 45)

Watching TV

Timer setting using EPG

You can select TV programmes using data from the EPG.

- 1 Press **EPG**.
- 2 Press **▲/▼/◀/▶** to select the programme you want to set, and then press **ENTER**.
- 3 Press **◀/▶** to select the timer setting, and then press **ENTER**.

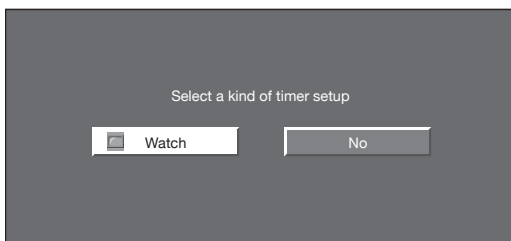

- If you select "No", the TV returns to the EPG screen.

■ Selecting "Watch" in the timer setup screen

This setting allows you to switch to a programme at a set time.

- ① Press **◀/▶** to select "Watch", and then press **ENTER**.
 - ② Press **◀/▶** to select "Yes", and then press **ENTER**.
- The selected TV programme is marked with an icon.

Cancelling the timer setting

- 1 Press **EPG**.
- 2 Press **▲/▼/◀/▶** to select the programme on timer setup, and then press **ENTER**.
- 3 Press **◀/▶** to select "Cancel", and then press **ENTER**.

■ Cancelling using B button on the remote control

- 1 Press **EPG**.
- 2 Press **B** to display the timer list screen.
- 3 Press **▲/▼** to select a programme you want to change, and then press **ENTER**.
- 4 Press **◀/▶** to select "Cancel" and then press **ENTER**.

Settings when using external devices

Settings when using HDMI output devices

HDMI terminals can carry audio and visual signals to the TV with an HDMI certified cable. When you want to output the audio and picture from an HDMI output device on the TV, select "INPUT1", "INPUT2" or "INPUT3" by switching the input source.

Connecting an HDMI output device

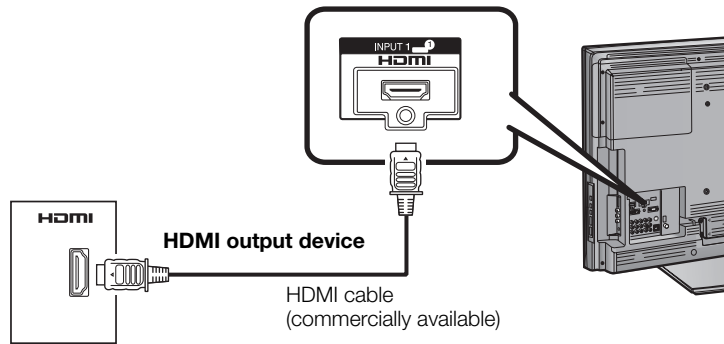

HDMI (High-Definition Multimedia Interface) Auto View

- 1 To watch an HDMI equipment image, select "INPUT1", "INPUT2" or "INPUT3" using **TV/VIDEO** on the remote control unit or on the TV.
- 2 Press **MENU** and the MENU screen displays.
- 3 Press **◀▶** to select "Setup".

- 4 Press **▲/▼** to select "HDMI auto view", and then press **ENTER**.

- The HDMI auto view can be selected only when "INPUT1", "INPUT2" or "INPUT3" is selected.

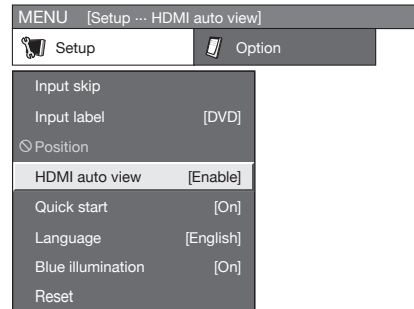

- 5 Press **◀▶** to select the desired item, and then press **ENTER**.

Selectable items	Description
Enable/Disable	Set whether or not to use WIDE MODE based on signal recognition, including an HDMI signal.

Settings when using external devices

Selecting the input source and signal type

Selecting input source

Can use for selecting the input source.

Using TV/VIDEO on the remote control unit or on the TV.

TV/VIDEO allows you to choose from the available input sources.

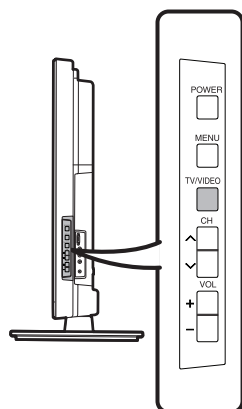
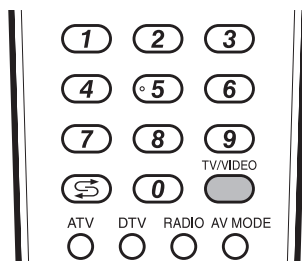

1 Press **TV/VIDEO** on the remote control unit or on the TV.

2 Press **TV/VIDEO** on the remote control unit or on the TV to select the input source.

- The image and sound from the selected source are output on the TV.
- You can also select the input source by pressing **▲/▼**.

Selecting input signal type

For setting the signal type of external equipment.

1 Press **MENU** and the MENU screen displays.

2 Press **◀/▶** to select "Option".

3 Press **▲/▼** to select "Input select", and then press **ENTER**.

4 Press **▲/▼** to select a signal type you want to set, and then press **ENTER**.

Input source	Selectable item
INPUT 4	Auto, COMPONENT, S-VIDEO, VIDEO
INPUT 6	Auto, COMPONENT, VIDEO

NOTE

- **If no (colour) image displays, try changing the other signal type.**
- Check the operation manual of the external equipment for the signal type.
- When the signal type is set to "Auto", the input terminal where a cable is connected is automatically selected.
- When the signal type is set to "Auto" and multiple video signal cables are connected, the signal type is selected in the following prioritised order:
INPUT 4: COMPONENT → S-VIDEO → VIDEO
INPUT 6: COMPONENT → VIDEO

Selecting the size of the picture for recording

You can use this function to set the appropriate picture size for recording a 16:9 format TV programme broadcast via DTV.

1 Press **MENU** and the MENU screen displays.

2 Press **◀/▶** to select "Digital setup".

3 Press **▲/▼** to select "REC picture size", and then press **ENTER**.

4 Press **◀/▶** to select the desired picture size, and then press **ENTER**.

Selected item	Description
16:9 TV	The TV displays the 16:9 format picture with black bands at the top and bottom of the screen.
4:3 TV	The picture gets compressed in the horizontal direction.

Settings when using external devices

Labelling input sources

You can assign each input source a label as you prefer.

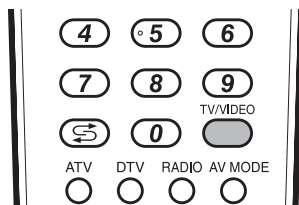

- 1 Press **TV/VIDEO** to select the desired input source.
- 2 Press **MENU** and the MENU screen displays.
- 3 Press **◀▶** to select "Setup".
- 4 Press **▲▼** to select "Input label", and then press **ENTER**.

- 5 Press **▲▼/◀▶** to select each character of the new name for the input source, and press **ENTER**.

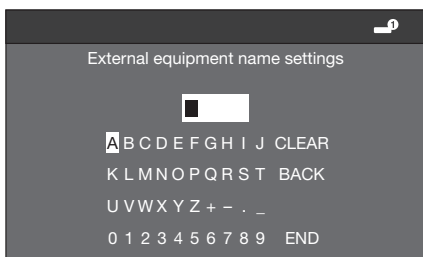

(Example)

- 6 Repeat until the name is fully spelt out.
 - The name can be 6 characters or less.
 - When you want to set an input source name of less than 6 characters, select "END", then press **ENTER** to exit from the labelling menu.

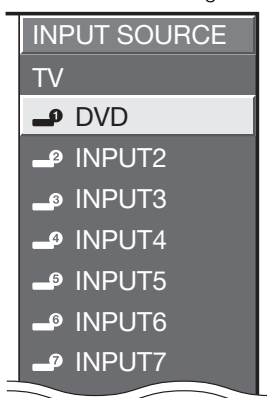

(Example)

NOTE

- You cannot change labels if the input source is TV.

Skipping HDMI/RGB input

This setting allows you to skip the HDMI or RGB input on the input source selection operation.

- 1 Press **MENU** and the MENU screen displays.
- 2 Press **◀▶** to select "Setup".
- 3 Press **▲▼** to select "Input skip", and then press **ENTER**.
- 4 Press **▲▼** to select the Input (INPUT1 to INPUT3 and INPUT7) you wish to skip, and then press **ENTER**.

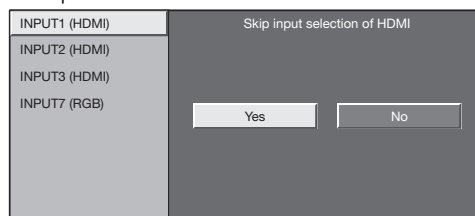

- 5 Press **◀▶** to select "Yes", and then press **ENTER**.
- 6 Press **MENU** to exit.

Colour system settings

You can change the colour system to one that is compatible with the image on the screen.

- 1 Press **MENU** and the MENU screen displays.
- 2 Press **◀▶** to select "Option".
- 3 Press **▲▼** to select "Colour system", and then press **ENTER**.
- 4 Press **▲▼** to select a compatible video signal system of your equipment, and then press **ENTER**.

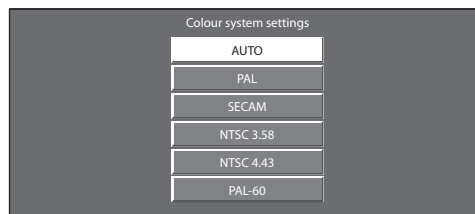

NOTE

- Factory preset value is "AUTO".
- If "AUTO" is selected, colour system for each channel is automatically set. If an image does not display clearly, select another colour system (e.g. PAL, NTSC 4.43).
- "Colour system" is selectable only when inputting an S-VIDEO or composite signal.

Settings when using external devices

Setting display colour

You can change the background colour of the OSD (menu screen), channel display and programme information, etc. to the blue, gray, red or green.

- 1 Press **MENU** and the MENU screen displays.
- 2 Press ◀▶ to select "Option".
- 3 Press ▲▼ to select "Setting display colour", and then press **ENTER**.
- 4 Press ▲▼ to select the desired colour, and then press **ENTER**.

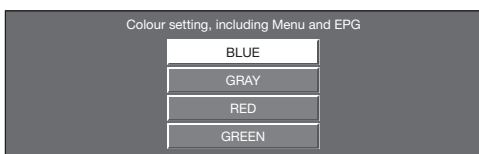

Channel selecting effect

This function shows a screen effect when choosing or changing channels.

- 1 Press **MENU** and the MENU screen displays.
- 2 Press ◀▶ to select "Option".
- 3 Press ▲▼ to select "Channel selecting effect", and then press **ENTER**.
- 4 Press ◀▶ to select "On", and then press **ENTER**.

AQUOS LINK

Controlling HDMI devices using AQUOS LINK

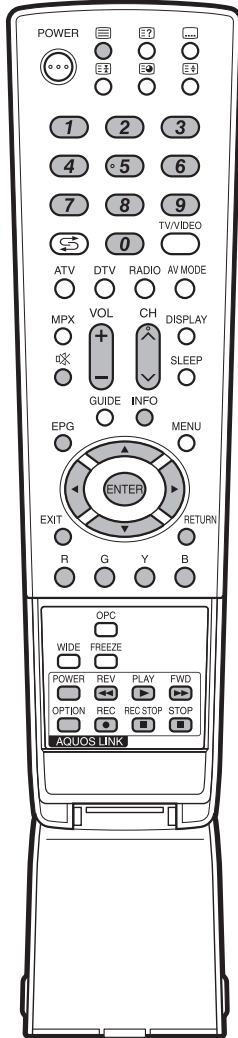

What is AQUOS LINK?

Using the HDMI CEC protocol, with AQUOS LINK you can interactively operate compatible system devices (AV amplifier, DVD player/recorder, Blu-ray player/recorder) using a single remote control unit.

What you can do with AQUOS LINK

✓ One Touch Recording (DTV only)

You do not have to search for the remote control unit of your recording device. Press the **REC** or **REC STOP** buttons inside the flip cover to start/stop recording what you see on the recorder.

✓ One Touch Play

While the TV is in standby mode, it will automatically turn on and play back the image from the HDMI source.

✓ Single remote control operation

AQUOS LINK automatically recognises the connected HDMI devices and you can control the TV and the devices as if using a universal remote control unit.

✓ Operating Title list of external devices

In addition to displaying the TV's own Timer list (Pages 43 and 44), you can also call up the external player's Top menu or AQUOS BD Player's/AQUOS Recorder's Title list provided that the devices support AQUOS LINK.

✓ Multiple control of HDMI devices

You can select which HDMI device to operate using the **OPTION** button.

NOTE

- When you use AQUOS LINK, make sure to use a certified HDMI cable.
- Point the remote control unit toward the TV, not to the connected HDMI device.
- Video noise may occur depending on the type of HDMI cable used. Make sure to use a certified HDMI cable.
- Up to three HDMI recording devices, one AV amplifier and two players can be connected using this system.
- These operations affect the HDMI device selected as the current external source. If the device does not operate, turn on the device and select the appropriate external source using **TV/VIDEO**.
- When you insert/remove HDMI cables or change connections, turn on all connected HDMI devices before turning on the TV. Confirm that picture and audio are correctly output by selecting "INPUT1", "INPUT2" or "INPUT3" from the "INPUT SOURCE" menu.

AQUOS LINK

AQUOS LINK connection

First connect the AQUOS AUDIO speaker system or an AQUOS BD Player/AQUOS Recorder that supports the HDMI CEC protocol.

NOTE

- Refer to the operation manual of the device to be connected for further details.
- After unplugging connection cables or changing the connection pattern, turn on the power of the TV after all relevant device's power have been turned on. Change the external input source by pressing **TV/VIDEO**, select the appropriate external source and verify the audiovisual output.
- The cables illustrated in the following explanation are commercially available items.

Connecting an AQUOS BD Player/AQUOS Recorder via the AQUOS AUDIO speaker system

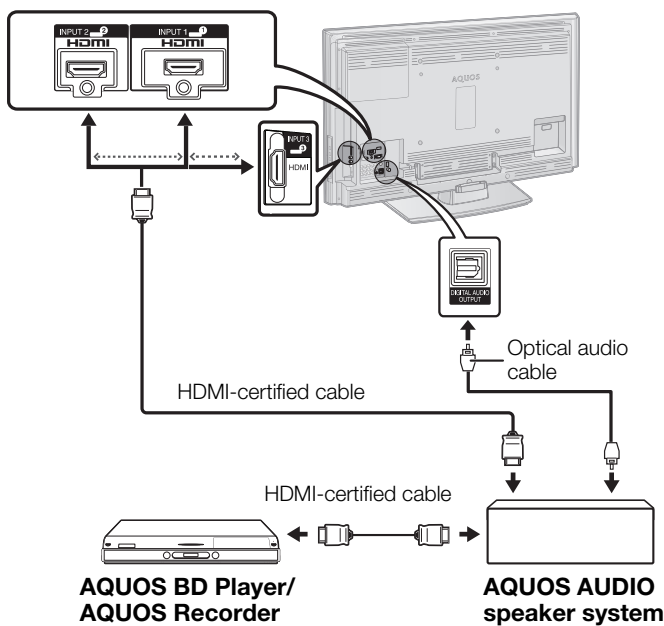

Connecting an AQUOS BD Player/AQUOS Recorder only

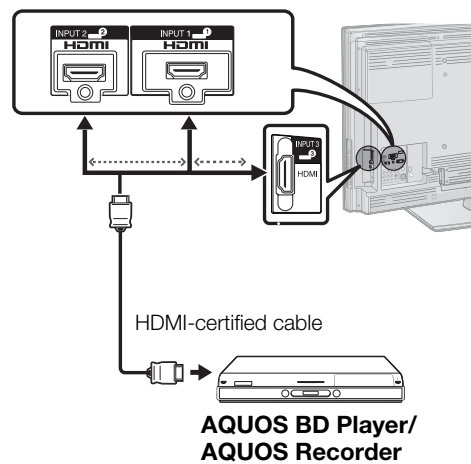

AQUOS LINK setup

AQUOS LINK control

Set to "On" to enable HDMI CEC functions.

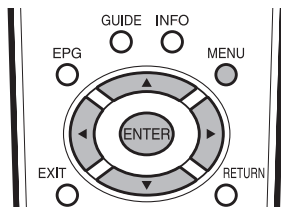

- 1 Press **MENU** and the MENU screen displays.
- 2 Press **◀▶** to select "Option".
- 3 Press **▲▼** to select "AQUOS LINK setup", and then press **ENTER**.

- 4 Press **▲▼** to select "AQUOS LINK control", and then press **ENTER**.

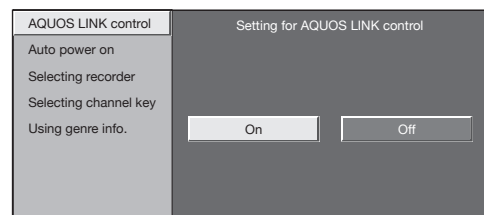

- 5 Press **◀▶** to select "On", and then press **ENTER**.
- 6 Press **MENU** to exit.

AQUOS LINK

Auto power on

If this is activated, the One Touch Play function is enabled. While the TV is in standby mode, it automatically turns on and plays back the image from the HDMI source.

1 Repeat steps 1 to 3 in **AQUOS LINK control**.

2 Press **▲/▼** to select “Auto power on”, and then press **ENTER**.

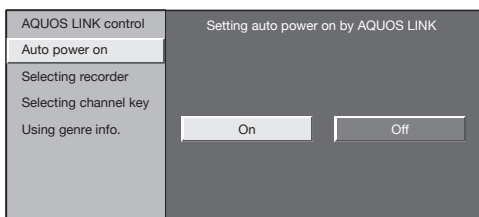

3 Press **◀/▶** to select “On”, and then press **ENTER**.

4 Press **MENU** to exit.

NOTE

- The factory default for this item is “Off”.

Selecting recorder

Here, you can select a recorder for the recording from several connected recorders.

1 Repeat steps 1 to 3 in **AQUOS LINK control**.

2 Press **▲/▼** to select “Selecting recorder”, and then press **ENTER**.

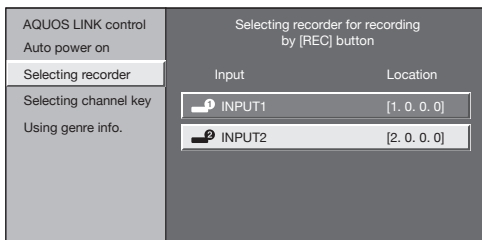

3 Select the recorder, and then press **ENTER**.

4 Press **MENU** to exit.

NOTE

- If you have connected the AQUOS AUDIO speaker system between the TV and an AQUOS Recorder, the external source's indication changes (e.g. from “INPUT 1” to “INPUT 1 (Sub)”).

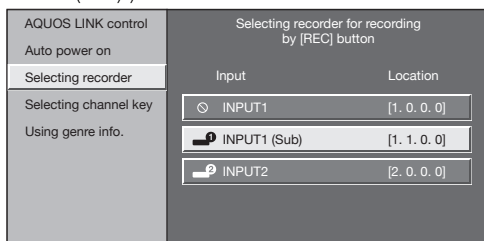

Selecting channel key

This function allows you to select the channel of the connected HDMI device using the TV's remote control unit.

1 Repeat steps 1 to 3 in **AQUOS LINK control**.

2 Press **▲/▼** to select “Selecting channel key”, and then press **ENTER**.

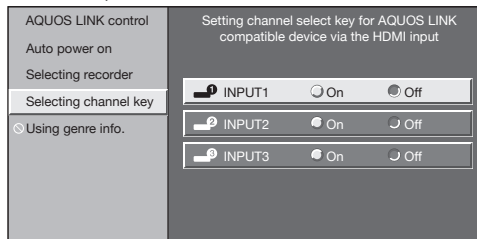

3 Press **▲/▼** to select the input source of the connected HDMI device you want to control using the TV's remote control unit, and then press **ENTER**.

4 Press **◀/▶** to select “On”, and then press **ENTER**.

Using genre info.

This function allows you to automatically switch to the appropriate sound mode depending on the genre information included in the digital broadcast.

1 Repeat steps 1 to 3 in **AQUOS LINK control**.

2 Press **▲/▼** to select “Using genre info.”, and then press **ENTER**.

3 Press **◀/▶** to select “On”, and then press **ENTER**.

Operating an AQUOS LINK device

AQUOS LINK allows you to operate the HDMI-connected device with a single remote control unit.

1 Open the remote control unit's flip cover.

2 Press **PLAY ▶** to start playback of a title.

- See page 53, section “**Playback of titles using AQUOS LINK**” if you want to start playback using the list of the titles of the AQUOS BD Player/ AQUOS Recorder.

3 Press **FWD ▶▶** to fast forward.

Press **REV ◀◀** to reverse.

Press **STOP ■** to stop.

Press **POWER** to turn the HDMI-connected device on/off.

AQUOS LINK

Listening with the AQUOS AUDIO speaker system

You can choose to listen to the TV sound only from the AQUOS AUDIO speaker system.

- 1 Open the remote control unit's flip cover, and then press **OPTION**.

- 2 Press **▲/▼** to select "By AQUOS AUDIO SP", and then press **ENTER**.

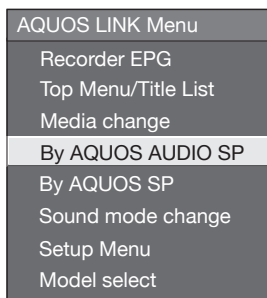

- The sound from the TV speaker and headphone terminal is silenced and only the sound from the AQUOS AUDIO speaker system is audible.

Listening with the AQUOS TV speaker system

You can choose to listen to the TV sound only from the AQUOS TV speaker system.

- 1 Open the remote control unit's flip cover, and then press **OPTION**.

- 2 Press **▲/▼** to select "By AQUOS SP", and then press **ENTER**.

Manually changing the AQUOS AUDIO speaker system's sound mode

- 1 Open the remote control unit's flip cover, and then press **OPTION**.

- 2 Press **▲/▼** to select "Sound mode change".

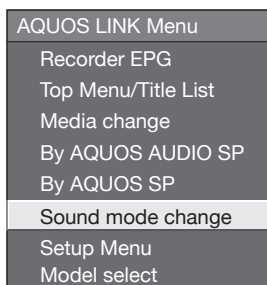

- 3 The sound mode changes every time you press **ENTER**.

- Refer to the operation manual of the AQUOS AUDIO speaker system for details.

Calling up the menu of an external device connected with the TV via HDMI

You can call up the menu of an HDMI CEC-compatible external device (player, recorder, decoder, etc.) using the "Setup Menu" function.

- 1 Open the remote control unit's flip cover, and then press **OPTION**.

- 2 Press **▲/▼** to select "Setup Menu", and then press **ENTER**.

NOTE

- If a connected device does not have this function or the device is in a status where the menu cannot be displayed (recording, entering standby, etc.), this function may not be available.

Playback of titles using AQUOS LINK

This section explains how to play back a title in the AQUOS BD Player/AQUOS Recorder.

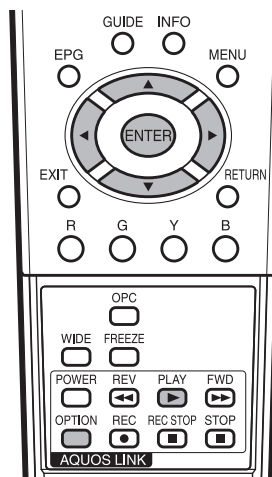

- 1 Open the remote control unit's flip cover, and then press **OPTION**.

- 2 Press **▲/▼** to select "Top menu/Title list", and then press **ENTER**.

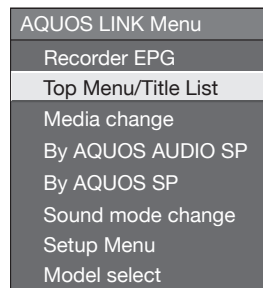

- The linked recorder now powers on and the TV automatically selects the appropriate external input source.
- The title list data from the connected AQUOS BD Player/AQUOS Recorder displays.

- 3 Select the title with **▲/▼/◀/▶**, and then press **PLAY ▶**.

AQUOS LINK

Selecting media type for CEC-compatible recorder

If your recorder has multiple storage media, select the media type here.

1 Open the remote control unit's flip cover, and then press **OPTION**.

2 Press **▲/▼** to select "Media change", and then press **ENTER**.

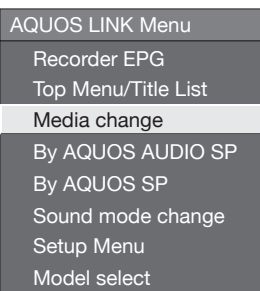

3 Select the desired medium, such as DVD recorder or HDD. The media type changes every time you press **ENTER**.

HDMI device selection

If multiple HDMI devices are connected in a daisy chain, you can specify which device to control here.

1 Open the remote control unit's flip cover, and then press **OPTION**.

2 Press **▲/▼** to select "Model select", and then press **ENTER**. The HDMI device changes every time you press **ENTER**.

Recording via the AQUOS Recorder EPG (only for recorders)

You can call up the CEC-compatible recorder's EPG and preset timer recordings using the TV's remote control unit.

1 Open the remote control unit's flip cover, and then press **OPTION**.

2 Press **▲/▼** to select "Recorder EPG", and then press **ENTER**.

- The external input source switches and the recorder's EPG is displayed.

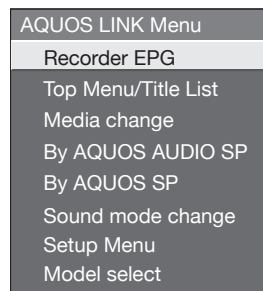

3 Select the programme to record.
• Refer to the operation manual of the recorder for details.

Connecting a PC

Use the PC terminals to connect a PC.

HDMI Connection

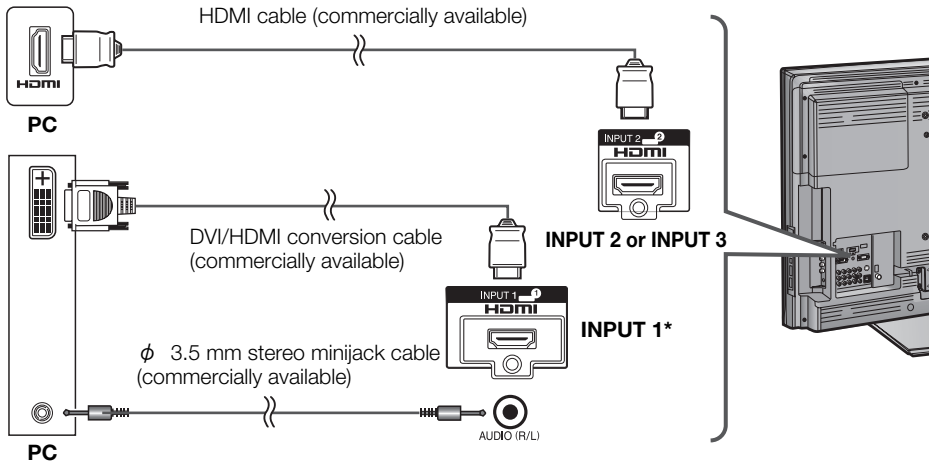

* When using the INPUT 1 terminal, you must select the proper item in the “PC audio select” menu depending on the type of HDMI cable connected. (See page 56.)

NOTE

- The PC INPUT terminals are DDC1/2B-compatible.
- Refer to page 59 for a list of PC signals compatible with the TV.

Analogue Connection

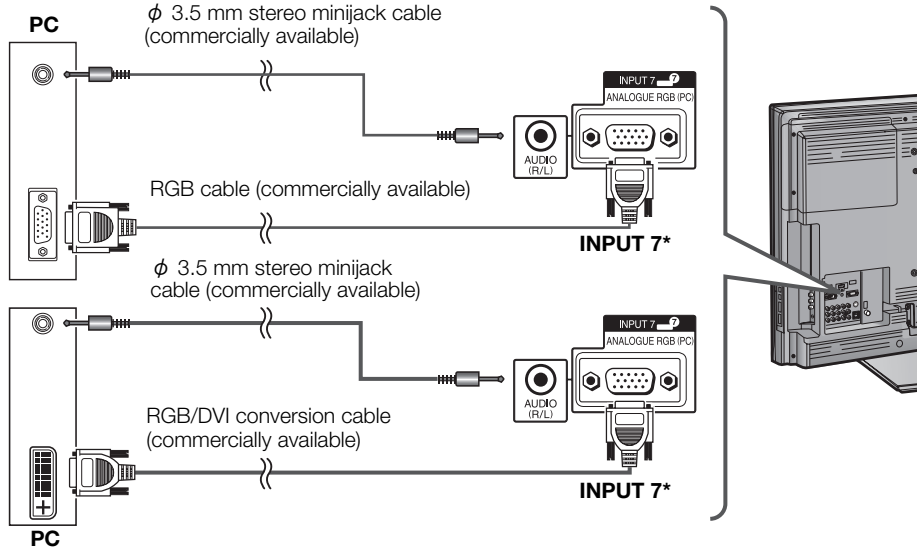

* When using the INPUT 7 terminal, you must select “INPUT7(RGB)” in the “PC audio select” menu. (See page 56.)

Signal names for 15-pin mini D-sub connector

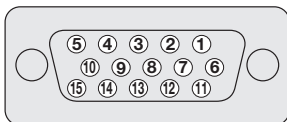

Pin No.	Signal name	Pin No.	Signal name	Pin No.	Signal name
①	R	⑥	GND (Ground)	⑪	Not connected
②	G	⑦	GND (Ground)	⑫	SDA
③	B	⑧	GND (Ground)	⑬	HD
④	Not connected	⑨	+5V	⑭	VD
⑤	CSYNC	⑩	GND (Ground)	⑮	SCL

NOTE

- Macintosh adaptor may be required for use for some Macintosh computers.
- Pin No. ⑤ is not used for inputting the signal.

Connecting a PC

PC audio select

When using the INPUT 7 terminal or INPUT 1 terminal, you must select which terminal uses the AUDIO (R/L) jack for analogue audio input.

Selected item	Description
INPUT1(HDMI)	When connecting devices (including a PC) with DVI/HDMI cable to the INPUT 1 terminal and inputting analogue audio signals from the AUDIO (R/L) jack.
INPUT7(RGB)	When connecting a PC to the INPUT 7 terminal, and inputting analogue audio signals from the AUDIO (R/L) jack.

NOTE

- You must set this to "INPUT7(RGB)" when connecting devices (including a PC) with an HDMI-certified cable to the INPUT 1 terminal. If "INPUT1(HDMI)" is set, there will be no sound output.

Displaying a PC image on the screen

Selecting the picture size

You can select the picture size as illustrated below.

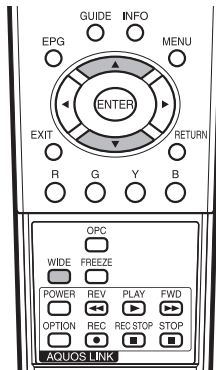

1

Press **WIDE**.

- The WIDE MODE menu displays.

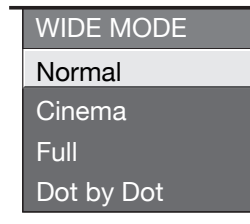

(Example)

2

Press **WIDE** or **▲/▼** to select a desired item on the menu.

NOTE

- Connect the PC before making adjustments.
- Selectable screen size may vary with input signal type.

EXAMPLE

Screen size images.

<p>Input Signal</p> <p>1024 × 768</p>	<p>Normal</p> <p>Keeps the original aspect ratio in a full screen display.</p>	<p>Cinema</p> <p>For viewing wide screen programs. The top and bottom of the image is slightly cropped.</p>	<p>Full</p> <p>An image fully fills the screen.</p>	<p>Dot by Dot</p> <p>Detects the resolution of the signal and displays an image with the same number of pixels on the screen.</p>
<p>Input Signal</p> <p>1360 × 768</p>	<p>Normal</p> <p>Keeps the original aspect ratio in a full screen display.</p>		<p>Full</p> <p>An image fully fills the screen.</p>	<p>Dot by Dot</p> <p>Detects the resolution of the signal and displays an image with the same number of pixels on the screen.</p>

Connecting a PC

Adjusting the PC image automatically

This function enables the screen to be automatically adjusted to its best possible condition when the analogue terminals of the TV and PC are connected with a commercially available DVI/D-sub conversion cable, etc.

- 1 Press **MENU** and the MENU screen displays.
- 2 Press **◀/▶** to select "Setup".
- 3 Press **▲/▼** to select "Auto sync.", and then press **ENTER**.
- 4 Press **◀/▶** to select "Yes", and then press **ENTER**.

- Auto sync. starts and "Adjusting the image" displays.

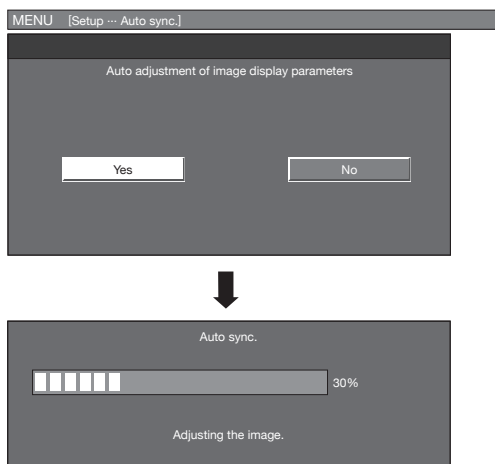

- 5 Press **MENU** to exit.

NOTE

- When Auto sync. is successful, "Auto sync completed successfully" displays. If not, Auto sync. failed.
- Auto sync. may fail even if "Auto sync completed successfully" displays.
- Auto sync. may fail if the computer image has low resolution, has unclear (black) edges, or is moved while executing Auto sync.
- Be sure to connect the PC to the TV and switch it on before starting Auto sync.
- Auto sync. can be executed only when inputting analogue signals.

Adjusting the PC image manually

Ordinarily you can easily adjust the picture as necessary to change image position using Auto sync. In some cases, however, manual adjustment is needed to optimise the image.

- 1 Press **MENU** and the MENU screen displays.
- 2 Press **◀/▶** to select "Setup".
- 3 Press **▲/▼** to select "Fine sync.", and then press **ENTER**.
- 4 Press **▲/▼** to select the specific adjustment item.

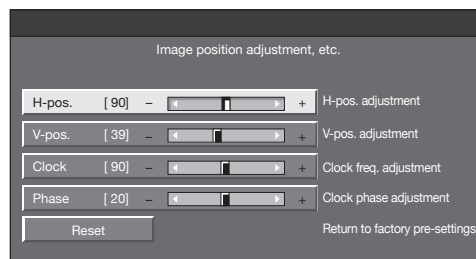

Selected item	Description
H-pos.	Centres the image by moving it to the left or right.
V-pos.	Centres the image by moving it up or down.
Clock	Adjusts when the image flickers with vertical stripes.
Phase	Adjusts when characters have low contrast or when the image flickers.

- 5 Press **◀/▶** to adjust the item to your desired position.
- 6 Press **MENU** to exit.

NOTE

- For resetting all adjustment items to the factory preset values, press **▲/▼** to select "Reset", and then press **ENTER**.
- "Clock" and "Phase" in the "Fine sync." menu can be adjusted only when inputting analogue signals.

Connecting a PC

PC Control of the TV

- When a programme is set, the TV can be controlled from the PC using the RS-232C terminal. The input signal (PC/video) can be selected, the volume can be adjusted and various other adjustments and settings can be made, enabling automatic programmed playing.
- Attach an RS-232C cable cross-type (commercially available) to the Din/D-sub RS-232C for the connections.

NOTE

- This operation system should be used by a person who is accustomed to using PCs.

Communication conditions

Set the RS-232C communications settings on the PC to match the communications conditions of the TV. The communications settings of the TV are as follows:

Baud rate:	9,600 bps
Data length:	8 bits
Parity bit:	None
Stop bit:	1 bit
Flow control:	None

Communication procedure

Send the control commands from the PC via the RS-232C connector.

The TV operates according to the received command and sends a response message to the PC.

Do not send multiple commands at the same time. Wait until the PC receives the OK response before sending the next command.

Command format

Eight ASCII codes + CR

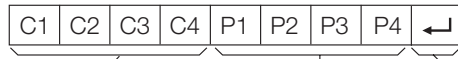

Command 4-digits Parameter 4-digits Return code

Command 4-digits: Command. The text of four characters.
Parameter 4-digits: Parameter 0 – 9, space, ?

Parameter

Input the parameter values, aligning left, and fill with space(s) for the remainder. (Be sure that four values are input for the parameter.)

When the input parameter is not correct, "ERR" returns. (Refer to "Response code format".)

0			
0	0	0	9
-	3	0	
1	0	0	
0	0	5	5

When "?" is input for some commands, the present setting value responds.

?			
?	?	?	?

Response code format

Normal response



Return code (ODH)

Problem response (communication error or incorrect command)



Return code (ODH)

Connecting a PC

PC compatibility chart

Resolution		Horizontal Frequency	Vertical Frequency	Analogue (D-Sub)	Digital (HDMI)	VESA Standard
VGA	640 × 480	31.5 kHz	60 Hz	✓	✓	✓
SVGA	800 × 600	37.9 kHz	60 Hz	✓	✓	✓
XGA	1024 × 768	48.4 kHz	60 Hz	✓	✓	✓
WXGA	1360 × 768	47.7 kHz	60 Hz	✓	✓	✓
SXGA	1280 × 1024	64.0 kHz	60 Hz	✓	✓	✓
SXGA+	1400 × 1050	65.3 kHz	60 Hz		✓	✓

NOTE

- This TV has only limited PC compatibility, correct operation can only be guaranteed if the video card conforms exactly to the VESA 60Hz standard. Any variations from this standard will result in picture distortions.

DDC is a registered trademark of Video Electronics Standards Association. Power Management is a registered trademark of Sun Microsystems, Inc. VGA and XGA are registered trademarks of international Business Machines Corp.

RS-232C commands list

Commands

- Commands not indicated here are not guaranteed to operate.

CONTROL ITEM	COMMAND	PARAMETER	CONTROL CONTENTS
POWER SETTING	P O W R 0	_ _ _ _	POWER OFF (STANDBY)
INPUT SELECTION A	I T G D	_ _ _ _	INPUT SWITCHING (TOGGLE)
	I T V D	_ _ _ _	TV (CHANNEL FXED)
	I D T V	_ _ _ _	DTV (CHANNEL FXED)
	I A V D *	_ _ _ _	INPUT1-7 (1-7)
CHANNEL	D C C H *	* _ _ _	TV DIRECT CHANNEL (1-99)
	C H U P	_ _ _ _	CHANNEL UP
	C H D W	_ _ _ _	CHANNEL DOWN
	D T V D *	* _ _ _	DTV DIRECT CHANNEL (1-999)
	D T U P	_ _ _ _	DTV CHANNEL UP
	D T D W	_ _ _ _	DTV DHANNEL DOWN
INPUT SELECTION B	I N P 4 0	_ _ _ _	INPUT4 (Auto)
	I N P 4 1	_ _ _ _	INPUT4 (COMPONENT)
	I N P 4 2	_ _ _ _	INPUT4 (S-VIDEO)
	I N P 4 3	_ _ _ _	INPUT4 (VIDEO)
	I N P 6 0	_ _ _ _	INPUT6 (Auto)
	I N P 6 1	_ _ _ _	INPUT6 (COMPONENT)
	I N P 6 3	_ _ _ _	INPUT6 (VIDEO)
AV MODE SELECTION	A V M D 0	_ _ _ _	TOGGLE
	A V M D 1	_ _ _ _	STANDARD
	A V M D 2	_ _ _ _	MOVIE
	A V M D 3	_ _ _ _	GAME
	A V M D 4	_ _ _ _	USER
	A V M D 5	_ _ _ _	DYNAMIC (Fixed)
	A V M D 6	_ _ _ _	DYNAMIC
	A V M D 7	_ _ _ _	PC
	A V M D 1 0 0	_ _ _ _	AUTO

NOTE

- If an underbar (_) appears in the parameter column, enter a space.
- If an asterisk (*) appears, enter a value in the range indicated in brackets under CONTROL CONTENTS.

CONTROL ITEM	COMMAND	PARAMETER	CONTROL CONTENTS
VOLUME	V O L M	* _ _ _	VOLUME (0-60)
POSITION	H P O S *	* _ _ _	H-POSITION (AV) (-nn - nn)
	H P O S *	* _ _ _	H-POSITION (PC) (-nn - nn)
	V P O S *	* _ _ _	V-POSITION (AV) (-nn - nn)
	V P O S *	* _ _ _	V-POSITION (PC) (-nn - nn)
	C L C K *	* _ _ _	CLOCK (0-180)
	P H S E *	* _ _ _	PHASE (0-40)
WIDE MODE	W I D E 0	_ _ _ _	TOGGLE (AV)
	W I D E 1	_ _ _ _	NORMAL (AV)
	W I D E 2	_ _ _ _	ZOOM 14:9 (AV)
	W I D E 3	_ _ _ _	PANORAMA (AV)
	W I D E 4	_ _ _ _	FULL (AV)
	W I D E 5	_ _ _ _	CINEMA 16:9 (AV)
	W I D E 6	_ _ _ _	CINEMA 14:9 (AV)
	W I D E 7	_ _ _ _	NORMAL (PC)
	W I D E 8	_ _ _ _	CINEMA (PC)
	W I D E 9	_ _ _ _	FULL (PC)
W I D E 1 0	_ _ _ _	DOT BY DOT (AV/PC)	
W I D E 1 1	_ _ _ _	UNDERSCAN (AV)	
MUTE	M U T E 0	_ _ _ _	TOGGLE
	M U T E 1	_ _ _ _	MUTE ON
	M U T E 2	_ _ _ _	MUTE OFF
SRS TS HD	A C S U 0	_ _ _ _	SRS TS HD TOGGLE
	A C S U 1	_ _ _ _	SRS TS HD ON
	A C S U 2	_ _ _ _	SRS TS HD OFF
AUDIO CHANGE	A C H A	_ _ _ _	TOGGLE
SLEEP TIMER	O F T M 0	_ _ _ _	OFF
	O F T M 1	_ _ _ _	SLEEP TIMER 30 MIN
	O F T M 2	_ _ _ _	SLEEP TIMER 1 HOUR
	O F T M 3	_ _ _ _	SLEEP TIMER 1 HOUR 30 MIN
	O F T M 4	_ _ _ _	SLEEP TIMER 2 HOUR
	O F T M 5	_ _ _ _	SLEEP TIMER 2 HOUR 30 MIN
TEXT	T E X T 0	_ _ _ _	TEXT OFF
	T E X T 1	_ _ _ _	TEXT ON (TOGGLE)
	D C P G *	* _ _ _	DIRECT PAGE JUMP (100-899)

Teletext function

About Teletext

What is Teletext?



Teletext broadcasts pages of information and entertainment to specially equipped television sets. Your TV receives Teletext signals broadcast by a TV network, and decodes them into graphical format for viewing. News, weather reports, sports information, stock exchange prices and programme previews are among the many services available.

Teletext mode

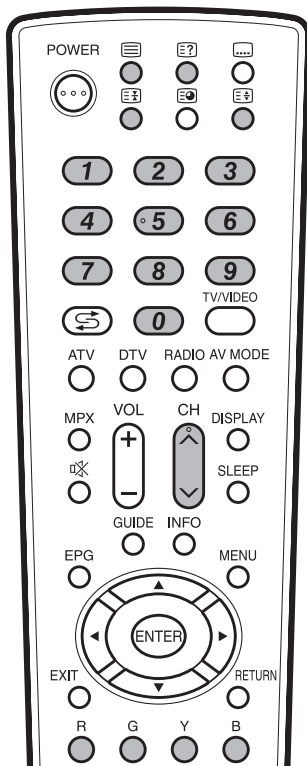
Teletext is turned on/off with  on the remote control unit. You can operate your TV in Teletext mode directly by inputting commands with the remote control unit.



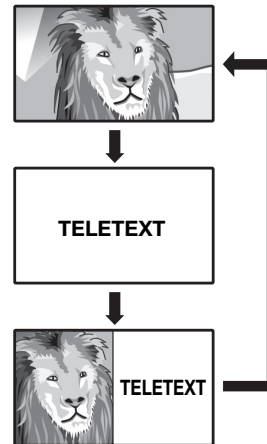

Turning on and off Teletext

- 1** Select a TV channel or external input source providing the Teletext programme.
- 2** Press  to display the Teletext.
- 3** Press  again to display the Teletext on the right screen and normal image on the left screen.
 - Each time you press , the screen switches as shown to the upper right.
 - If you select a programme with no Teletext signal, "No Teletext available" is displayed.
 - The same message displays during other modes if no Teletext signal is available.



When viewing the Teletext information

- Press **CH**  to increase the page number.
- Press **CH**  to decrease the page number.

Button functions

Colour (Red/Green/Yellow/Blue):

You can select a group or block of pages displayed in the coloured brackets at the bottom of the screen by pressing the corresponding **Colour (Red/Green/Yellow/Blue)** on the remote control unit.

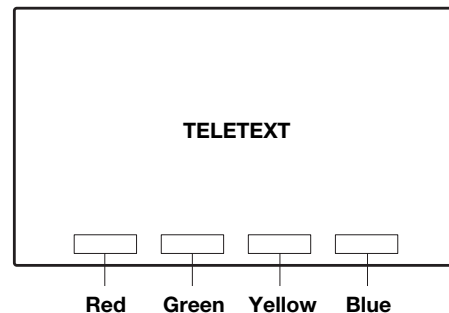

0 - 9:

Directly select any page from 100 to 899 by using **0 - 9**.

(Top/Bottom/Full):

Each time you press , the TELETEXT image switches as shown below.

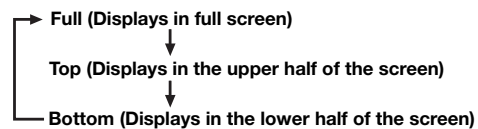



(Reveal hidden for TELETEXT):

To reveal hidden information such as an answer to a quiz, press .

- Press  again to hide the information.

(Hold):

To stop updating Teletext pages automatically, press .

- Press  again to release the hold mode.

Teletext function

Teletext language setting

If Teletext information does not display correctly, perform the procedure below. Select from among 4 kinds of language tables: West Europe, East Europe, Greek/Turkish, Cyrillic. Each table is compatible with the Teletext languages listed below.

1 Press **MENU** and the MENU screen displays.

2 Press ◀▶ to select "Setup".

3 Press ▲▼ to select "Text language", and then press **ENTER**.

4 Press ▲▼ to select receivable teletext broadcasting language in your country.

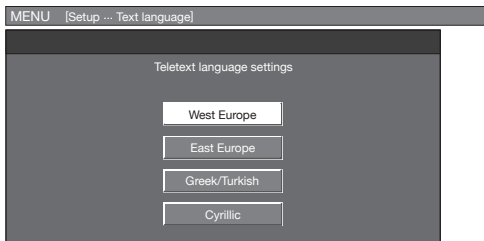

- West Europe – English, French, Scandinavian, Czech, German, Spanish, Italian
- East Europe – Polish, French, Scandinavian, Czech, German, Slovenian/Croatian, Italian, Rumanian
- Greek/Turkish – English, French, Scandinavian, Turkish, German, Spanish, Italian, Greek
- Cyrillic – English, Russian, Estonian, Czech, German, Spanish, Ukrainian, Lettish

NOTE

- Teletext can display only when it is sent by a network. Not used to convert between languages.

Displaying Subpages

You can display subpages as they are transmitted.

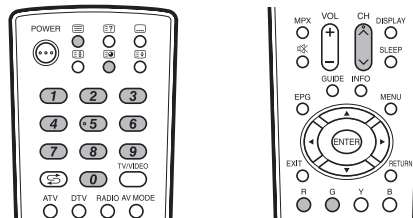

1 Press to display Teletext.

2 Press to display the subpage as shown below.

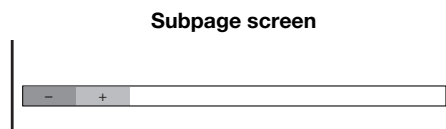

3 Select the desired subpage by using **CH**▲▼, **Red** or **Green**.

- 0 – 9 directly selects the desired subpage.

4 Press to exit the subpage screen.

Time display

You can display the time information included in the Teletext broadcast.

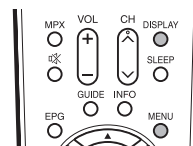

1 Select a TV channel providing Teletext information.

(The time information is automatically captured.)

2 Press **DISPLAY**. The channel display will appear on the display.

3 Press **DISPLAY** again. The channel display about three seconds on the screen. Time information will continuously display on the lower right of the screen.

4 Even when you change the TV channel, you can display the time information with steps 2 to 3 above.

NOTE

- The time display cannot be stored once the power is turned off. When you turn on the power, perform steps 1 to 4 again.
- If acquired successfully the time information will appear in the upper-right corner of the screen by pressing **MENU**.

Teletext function

Displaying Subtitles

You can display subtitles as they are transmitted.

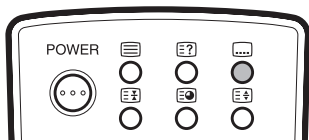

- 1 Press to display the subtitle.
 - Subtitle is updated by information sent by the broadcasting station.
- 2 Press to exit the subtitle screen.

NOTE

- Subtitle will not be displayed when the service does not contain subtitle information.

Switching subtitle languages

Each time you press on the remote control, the subtitle switches

Set “For hearing impaired” to “Yes”



Set “For hearing impaired” to “No”

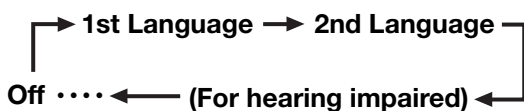

Selecting the Language

- 1 Press **MENU** and the MENU screen displays.
- 2 Press to select “Digital setup”.
- 3 Press / to select “Subtitle”, and then press **ENTER**.
- 4 Press / to select “1st language” or “2nd language”, and then press **ENTER**.
- 5 Press / to select the desired language, and then press **ENTER**.

Displaying subtitles for the hearing impaired

You can display subtitles for the hearing impaired in the Teletext broadcast.

- 1 Press **MENU** and the MENU screen displays.
- 2 Press to select “Digital setup”.
- 3 Press / to select “Subtitle”, and then press **ENTER**.
- 4 Press / to select “For hearing impaired”, and then press **ENTER**.
- 5 Press to select “Yes”, and then press **ENTER**.

Appendix

Troubleshooting

The problems described below are not always caused by malfunctions. Check the TV again before having the TV serviced.

Problem	Possible Solution
<ul style="list-style-type: none"> No power. 	<ul style="list-style-type: none"> Check if you pressed POWER on the remote control unit. (See page 16.) If the indicator on the TV lights up red, press POWER. Is the AC cord disconnected? (See page 10.) Has the power been turned on? (See page 16.)
<ul style="list-style-type: none"> Unit cannot be operated. 	<ul style="list-style-type: none"> External influences such as lightning, static electricity, etc., may cause improper operation. In this case, operate the unit after first turning the power off the TV or unplugging the AC cord and re-plugging it in after 1 or 2 minutes.
<ul style="list-style-type: none"> Remote control unit does not operate. 	<ul style="list-style-type: none"> Are batteries inserted with polarity (+, -) aligned? (See page 15.) Are batteries worn out? (Replace with new batteries.) Are you using it under strong or fluorescent lighting? Is a fluorescent light shining on the remote control sensor?
<ul style="list-style-type: none"> Picture is cut off. 	<ul style="list-style-type: none"> Is the image position correct? (See page 36.) Are screen mode adjustments such as picture size made correctly? (See pages 31, 32 and 56.)
<ul style="list-style-type: none"> Strange colour, light colour, or dark, or colour misalignment. 	<ul style="list-style-type: none"> Adjust the picture tone. (See pages 34 to 36.) Is the room too bright? The picture may look dark in a room that is too bright. Check the colour system setting. (See pages 23 and 48.) Check the HDMI auto view setting. (See page 46.)
<ul style="list-style-type: none"> Power is suddenly turned off. 	<ul style="list-style-type: none"> The unit's internal temperature has increased. Remove any objects blocking the vent or clean. Check the ECO setting. (See page 30.) Is the sleep timer set? (See page 30.)
<ul style="list-style-type: none"> No picture. 	<ul style="list-style-type: none"> Is the connection to external equipment correct? (See pages 13 and 14.) Is the correct input selected? (See page 47.) Is the picture adjustment correct? (See pages 34 to 36.) Is the antenna connected properly? (See page 10.) Is "On" selected in "Audio only"? (See page 26.)
<ul style="list-style-type: none"> No sound. 	<ul style="list-style-type: none"> Is the volume too low? (See page 21.) Make sure that headphones are not connected. (See page 8.)
<ul style="list-style-type: none"> The TV sometimes makes a cracking sound. 	<ul style="list-style-type: none"> This is not a malfunction. This happens when the cabinet slightly expands and contracts according to changes in temperature. This does not affect the TV's performance.

Troubleshooting-Digital broadcasting

The error message about reception of broadcast

The example of an error message displayed on a screen	Error code	Possible Solution
<ul style="list-style-type: none"> Failed to receive broadcast. 	E202	<ul style="list-style-type: none"> Check the antenna cable. Check that the antenna is correctly setup.
<ul style="list-style-type: none"> No broadcast now. 	E203	<ul style="list-style-type: none"> Check the broadcast time in the program guide.

Cautions regarding use in high and low temperature environments

- When the unit is used in a low temperature space (e.g. room, office), the picture may leave trails or appear slightly delayed. This is not a malfunction, and the unit will recover when the temperature returns to normal.
- Do not leave the unit in a hot or cold location. Also, do not leave the unit in a location exposed to direct sunlight or near a heater, as this may cause the cabinet to deform and the LCD panel to malfunction.
Storage temperature: -20°C to +60°C.

Appendix

Error messages about recording using AQUOS LINK

The example of an error message displayed on a screen	Error code	Possible Solution
Failed to record Cannot record the broadcast.	S05	Check the content (broadcast or programme) or the recording medium such as HDD or DVD. Either the content or the recording medium may be incompatible.
Failed to record Cannot record the broadcast.	S06	This network cannot be recorded. Use the recording function of your recording device, not the AQUOS LINK function.
Failed to record Cannot record the broadcast.	S07	
Failed to record	S09	Use the recording function of your recording device, not the AQUOS LINK function.
Failed to record	S10	
Failed to record	S11	
Failed to record	S12	
Failed to record Cannot record the programme.	S13	Check the content (broadcast or programme). It may be incompatible.
Failed to record Cannot record the programme.	S14	
Failed to record No record media available.	S16	Check the recording medium.
Failed to record Cannot record while playback.	S17	Stop playback and set up the recording again.
Failed to record Cannot record while recording other programme.	S18	During recording, another recording is not possible.
Failed to record No record media available.	S19	Check the recording medium. Writing to the medium is prohibited.
Failed to record Cannot record while not receiving broadcast.	S20	Please check if the settings are properly set. Broadcasts are not receivable.
Failed to record No record media available.	S21	Recording to the medium is not possible. Check the recording medium.
Failed to record No recordable memory available.	S22	Check the capacity of the recording medium.
Failed to record Age limitation is set.	S23	Deactivate the child lock and set up the recording again.
Failed to record Cannot record with the recorder.	S31	Check your recording device.

Appendix

Reset

If complex adjustments are made and the settings cannot be restored to normal, you can reset the settings to the factory preset values.

1 Press **MENU** and the MENU screen displays.

2 Press **◀▶** to select "Setup".

3 Press **▲▼** to select "Reset", and then press **ENTER**.

4 If you have already set the password, enter it here.

- "Return to factory pre-settings" displays on the screen.

5 Press **◀▶** to select "Yes", and then press **ENTER**.

- "Now, TV will restart automatically. OK?" displays on the screen.

6 Press **◀▶** to select "Yes", and then press **ENTER**.

- "Now initialising..." displays on the screen and blinks.
- After the reset has completed, the power shuts off and then comes back on. The screen will have returned to its original settings.

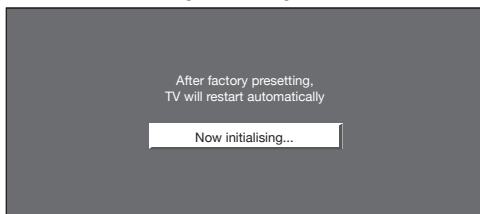

7 Press **▲▼** to select the desired language listed on the screen, and then press **ENTER**. Press **◀▶** to select "HOME" or "STORE", and then press **ENTER**.

8 Press **ENTER**.

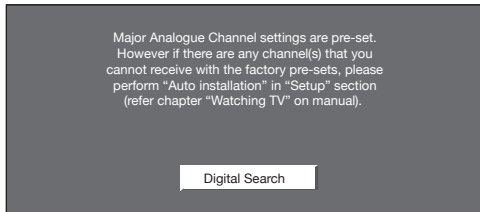

- Major analogue channel settings are pre-set. However if there are any channel(s) that you cannot receive with the factory pre-sets, please perform "Auto installation" in "Setup" section. (See page 20.)

9 The TV searches for, sort and stores all the receivable TV stations according to their settings and the connected antenna.

- To abort the initial auto installation in progress, press **RETURN**.

NOTE

- When the TV is in STORE mode, repeat steps 1 to 7 to change to HOME mode.

Download setup

The TV automatically determines whether a new software version is available when the TV is in standby mode.

Selected item	Description
Yes	Automatically searches for new software updates available when the TV is in standby mode.
No	Does not search for update information.
Now	Checks if there is new software immediately.

Downloading the software

You can select the method of update.

1 If the software is updated, the confirmation message "New download information has been detected." appears

- If the TV receives the update service while in standby mode, a confirmation message displays after turning on the power.

2 Follow the screen prompts.

Selected item	Description
Yes	Starts downloading immediately. It takes approximately one hour to update. You cannot carry out other operations while downloading. <ul style="list-style-type: none"> • Cancels the download by pressing ENTER on the remote control unit when "Discontinue" is displayed on the screen during the update.
No	Starts downloading automatically several minutes after entering standby mode.

NOTE

- The TV must remain in standby mode for download. Do not turn off the power using **POWER** on the TV.
- Updating the software may take some time.

Information

Message list

When a new broadcast station is detected, the message is updated in the "Message list" of the "Information" menu.

Receiver report

Display reports regarding failures and changes for timer settings.

Identification

You can check the current version of the software on the screen.

Appendix

Specifications

Item		Model	LC-40LE700X
LCD panel		40" (1016 mm) Advanced Super View & BLACK TFT LCD	
Resolution		2,073,600 pixels (1920 × 1080)	
Video Colour System		PAL/SECAM/NTSC 3.58/NTSC 4.43/PAL 60	
TV Function	TV-Standard	Analogue	PAL: B/G, D/K, I SECAM: B/G, D/K, K/K _i
		Digital	DVB-T
	Receiving Channel	VHF/UHF	44.25 – 863.25 MHz
		CATV	S1 – S41ch (including Hyperband)
	TV-Tuning System	Auto Preset 99 ch	
STEREO/BILINGUAL		NICAM: B/G, I, D/K A2 stereo: B/G	
Backlight life		100,000 hours (at Backlight Standard position)	
Viewing angles		H : 176° V : 176°	
Audio amplifier		10W × 2	
Speakers		10 × 4 cm 2pcs	
Terminals	Rear	ANTENNA IN	UHF/VHF 75 Ω DIN type
		INPUT 1	HDMI (HDMI input) (480I, 576I, 480P, 576P, 720P/50Hz, 720P/60Hz, 1080I/50Hz, 1080I/60Hz, 1080P/50Hz, 1080P/60Hz, 1080P/24Hz), AUDIO in (ϕ 3.5 mm jack)
		INPUT 2	HDMI (HDMI input) (480I, 576I, 480P, 576P, 720P/50Hz, 720P/60Hz, 1080I/50Hz, 1080I/60Hz, 1080P/50Hz, 1080P/60Hz, 1080P/24Hz)
		INPUT 3	HDMI (HDMI input) (480I, 576I, 480P, 576P, 720P/50Hz, 720P/60Hz, 1080I/50Hz, 1080I/60Hz, 1080P/50Hz, 1080P/60Hz, 1080P/24Hz)
		INPUT 4	VIDEO in, AUDIO in, S-VIDEO in, COMPONENT in (480I, 576I, 480P, 576P, 720P/50Hz, 720P/60Hz, 1080I/50Hz, 1080I/60Hz)
		INPUT 5	VIDEO in, AUDIO in
		INPUT 6	VIDEO in, AUDIO in, COMPONENT in (480I, 576I, 480P, 576P, 720P/50Hz, 720P/60Hz, 1080I/50Hz, 1080I/60Hz)
		INPUT 7 (PC input)	15 pin mini D-sub, AUDIO in (common use with INPUT1) (ϕ 3.5 mm jack)
		MONITOR OUT	VIDEO out, AUDIO out
		RS-232C	9 pin D-sub male connector
DIGITAL AUDIO OUTPUT		Optical Digital Audio output	
OSD language		English/Simplified Chinese/Arabic	
Power Requirement		AC 110 – 240 V, 50/60 Hz	
Power Consumption		139 W (0.4 W Standby)	
Weight	without stand	12.5 kg	
	with stand	15.5 kg	
Operating Temperature		0°C – 40°C	

- As a part of policy of continuous improvement, SHARP reserves the right to make design and specification changes for product improvement without prior notice. The performance specification figures indicated are nominal values of production units. There may be some deviations from these values in individual units.

Optional accessory

The listed optional accessory is available for the LCD colour TV. Please purchase it at your nearest shop.

- Additional optional accessories may be available in the near future. When purchasing, please read the newest catalogue for compatibility and check the availability.

Part name	Model number
Wall mount bracket	AN-37AG2
Attachment	AN-37P30*

- * The AN-37P30 attachment is always required when attaching the AN-37AG2 bracket to a wall.

Appendix

Dimensional drawings

Unit: mm

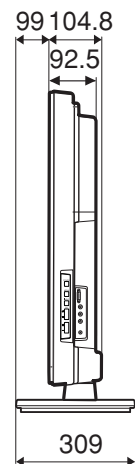
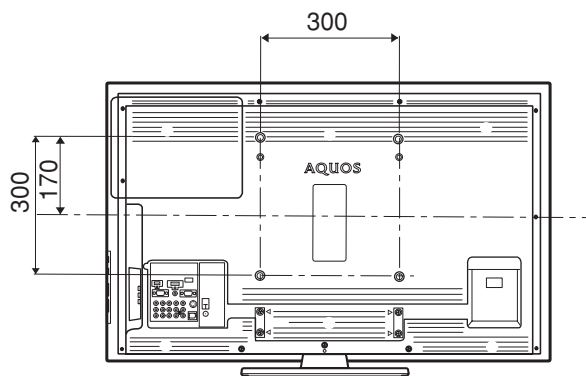
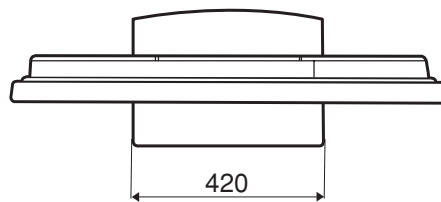
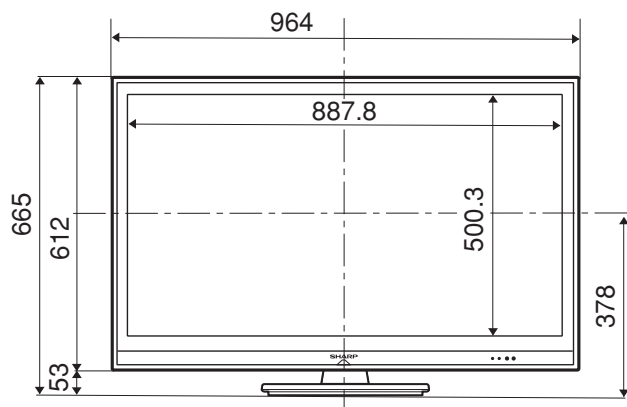

Appendix

Mounting the TV on the wall

Removing the stand

For wall mounting with the optional bracket, remove the stand.

Before detaching/attaching the stand

- Before detaching (or attaching) the stand, unplug the AC cord from the AC outlet.
- Remove all terminal covers and connected cables.
- Lay the TV down on cushioning (such as a blanket) over a table.
- Make sure two or more people perform the operation.

CAUTION

- **Do not remove the stand from the TV unless using an optional bracket to mount it.**

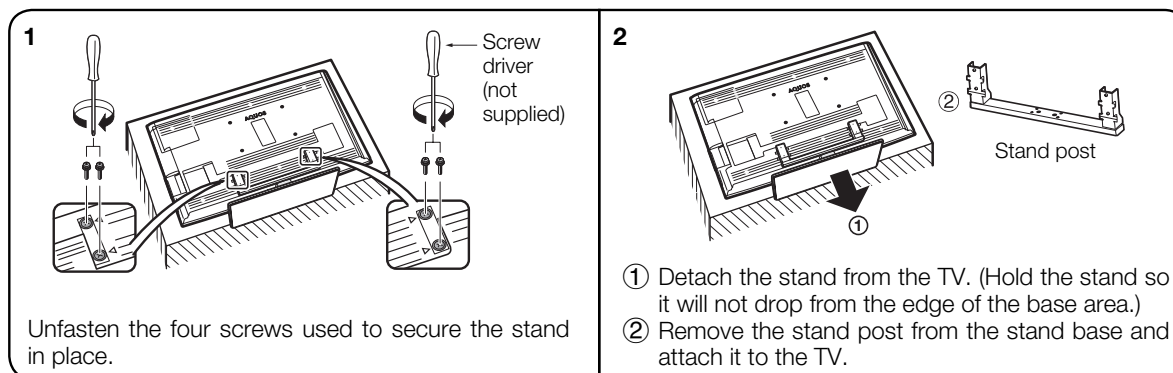

NOTE

- To attach the stand, perform the above steps in reverse order.

Handling and precautions with the wall-mounted TV

- You can mount the TV on the wall using the optional AN-37AG2 bracket and AN-37P30 attachment.
- For details, refer to the instructions supplied with the optional bracket.

CAUTION

- **This TV should be mounted on the wall only with the AN-37AG2 (SHARP) / AN-37P30 (SHARP) wall mount bracket. The use of other wall mount brackets may result in an unstable installation and may cause serious injuries.**
- **Installing the Liquid Crystal Television requires special skill that should only be performed by qualified service personnel. Customers should not attempt to do the work themselves. SHARP bears no responsibility for improper mounting or mounting that results in accident or injury.**

Using an optional bracket to mount the TV

- You can ask a qualified service personnel about using an optional AN-37AG2 bracket and AN-37P30 attachment to mount the TV to the wall.
- Carefully read the instructions that come with the bracket before beginning work.

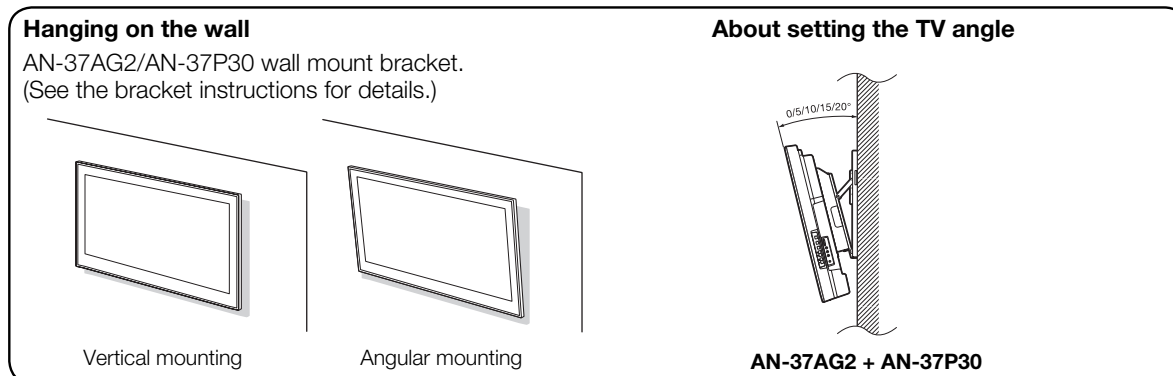

NOTE

- Detach the cable clamps on the rear of the TV when using the optional mount bracket.
- To use this TV mounted on a wall, first remove the cover at the 4 locations on the rear of the TV, and then use the screws supplied with the wall mount bracket to secure the bracket to the rear of the TV.

Appendix

Protection against overturning

There is a danger of the product overturning in the case of a disaster or sudden collision. Carry out the following tip-resistant measurement for your safety.

Anchoring the TV to the wall or a pillar

- 1 Fix the product with the 2 clamps (supplied), using the screws (supplied).
- 2 Fix the TV to the wall using extrastrong ties (commercially available).

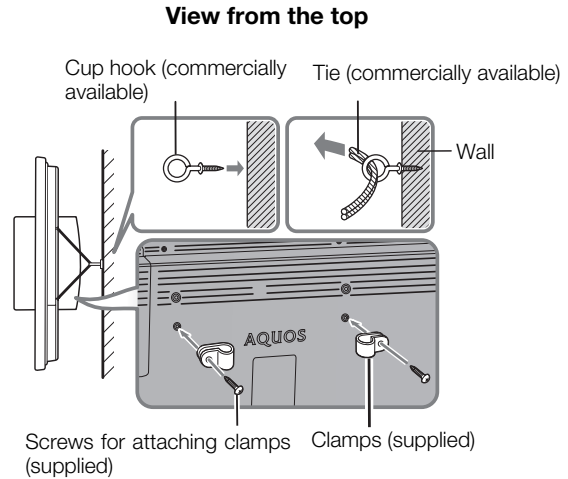

Fixing the TV to the table

- 1 Lay the TV down on cushioning (such as a blanket) over a table.
- 2 Attach the band (supplied) to the bottom of the stand using the screw (supplied).
- 3 Transfer the product to the table where you intend to fix the TV.
- 4 Fix the TV to the table by the band with a screw (commercially available).
 - Use a screw (commercially available) whose shape is compatible with the band.

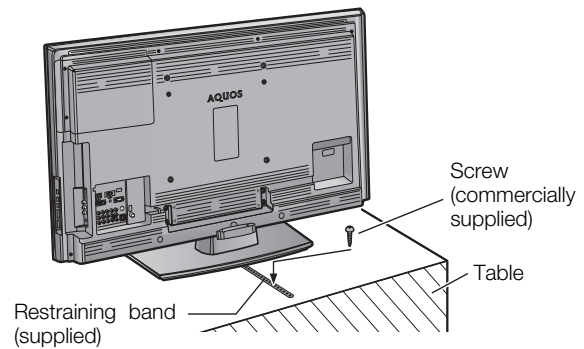
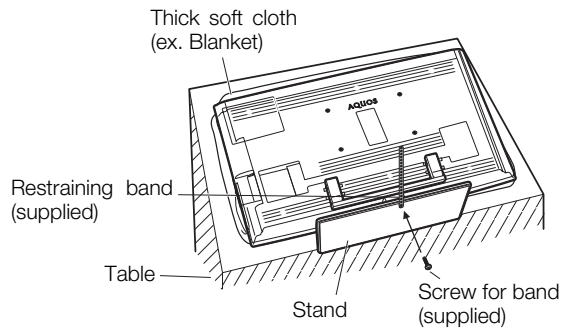

CAUTION

- As this product is heavy, use a table that is wide enough to support the product and capable of withstanding the product's weight. The table should be set where it will not be overturned.

Appendix

CLEARING THE PASSWORD

If you forget the password, clear the password using the following procedure.

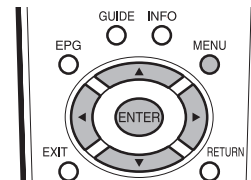

1 Press **MENU** to display the MENU screen, and then press ◀/▶ to select "Setup".

2 Press ▲/▼ to select "Auto installation", "Programme setup", "Child lock", "Reset", and the password input screen displays.

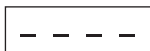

3 Press and hold both **CH▲** and **VOL+** on the TV simultaneously until the message appears on the screen.

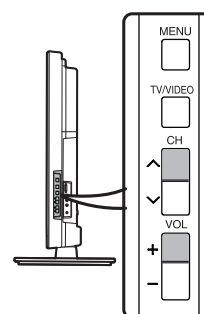

The Password is

----- ✂ -----

--	--	--	--

.

NOTE

- As a precautionary measure, make a note of your password above, remove it from this manual, and keep it in a familiar place.



Appendix

Information on the software license for this product

Software composition

The software included in this product is comprised of various software components whose individual copyrights are held by SHARP or by third parties.

Software developed by SHARP and open source software

The copyrights for the software components and various relevant documents included with this product that were developed or written by SHARP are owned by SHARP and are protected by the Copyright Act, international treaties, and other relevant laws. This product also makes use of freely distributed software and software components whose copyrights are held by third parties. These include software components covered by a GNU General Public License (hereafter GPL), a GNU Lesser General Public License (hereafter LGPL) or other license agreement.

Obtaining source code

Some of the open source software licensors require the distributor to provide the source code with the executable software components. GPL and LGPL include similar requirements. For information on obtaining the source code for the open source software and for obtaining the GPL, LGPL, and other license agreement information, visit the following website:

<http://www.sharp.net.au/>

We are unable to answer any questions about the source code for the open source software. The source code for the software components whose copyrights are held by SHARP is not distributed.

Acknowledgements

The following open source software components are included in this product:

- linux kernel
- busy box
- uClibc
- zlib
- libpng
- libjpeg



Memo





SHARP

FOR LOCATION ENQUIRIES WITHIN

AUSTRALIA

REGARDING YOUR LOCAL

SHARP APPROVED SERVICE CENTRE

VISIT OUR WEBSITE AT

www.sharp.net.au

OR CALL SHARP CUSTOMER CARE

1300 135 022

(LOCAL CALL COST APPLY WITHIN AUSTRALIA)

SHARP CORPORATION OF AUSTRALIA PTY LTD

SHARP

FOR LOCATION ENQUIRIES WITHIN

NEW ZEALAND

REGARDING YOUR LOCAL

SHARP APPROVED SERVICE CENTRE

VISIT OUR WEBSITE AT

www.sharp.net.nz

CONTACT YOUR SELLING DEALER/RETAILER

OR CALL

SHARP CUSTOMER SERVICES

TELEPHONE: 09 573 0111

FACSIMILE: 09 573 0113

SHARP CORPORATION OF NEW ZEALAND LIMITED

SPform019(JUNE 2004)





SHARP

WARRANTY *Consumer Electronic Products* Congratulations on Your Purchase!

This Sharp product is warranted against faults in materials and manufacture for a period of twelve (12) months from the date of original purchase.

If service is required during the warranty period, please contact your nearest Sharp Approved Service Centre. These repairs would be carried out at no charge to the owner, subject to the conditions specified herein.

The owner is responsible for any transportation and insurance costs if the product has to be returned for repair.

This warranty does not extend to accessories or defects or injuries caused by or resulting from causes not attributable to faulty parts or the manufacture of the product, including but not limited to, defect or injury caused by or resulting from misuse, abuse, neglect, accidental damage, improper voltage, liquid spillage, vermin infestation, software, or any alterations made to the product which are not authorised by Sharp.

Please retain your sales documentation, as this should be produced to validate a warranty claim.

This warranty is in addition to and in no way limits, varies or excludes any express and implied rights and remedies under any relevant legislation in the country of sale.

IMPORTANT DO NOT RETURN THIS DOCUMENT TO SHARP

For your reference, please enter the particulars of your purchase below and retain, with your purchase documentation.

Model No. _____

Serial No. _____

Date of Purchase _____

Retailer _____

SHARP
SHARP CORPORATION OF AUSTRALIA PTY. LIMITED
ABN 40 003 039 405
1 Huntingwood Drive
Huntingwood NSW2148
SHARP CORPORATION OF NEW ZEALAND LIMITED
59 Hugo Johnston Drive
Penrose, Auckland
SFForm030 (JUNE 2004)

IMPORTANT NOTICE: This warranty applies only to products sold in Australia & New Zealand

SHARP®

SHARP CORPORATION

Printed in Malaysia
TINS-E304WJZZ
09P07-MA-NF

